

Keysight PXIe Vector Network Analyzers

M9370A 300 kHz to 4 GHz

M9371A 300 kHz to 6.5 GHz

M9372A 300 kHz to 9 GHz

M9373A 300 kHz to 14 GHz

M9374A 300 kHz to 20 GHz

M9375A 300 kHz to 26.5 GHz



Data Sheet and
Technical
Specifications

Drive down the size of test

When you need to measure basic S-parameters, the right mix of speed, performance and footprint gives you an edge. Sharpen your edge with the Keysight PXI vector network analyzer (VNA), ideal for:

- Wireless manufacturing test
- Handset component test
- Aerospace/defense depot maintenance level testing
- Aerospace/defense manufacturing test

Get more VNA in less space

The Keysight PXI VNA is a full two-port VNA that fits in just one slot. The PXI VNA also performs fast, accurate measurements and reduces your cost-of-test by letting you simultaneously characterize many devices -- two-port or multiport -- using a single PXI chassis.

It offers the best PXI VNA performance on key specifications such as dynamic range, measurement speed, and trace noise. Each module is a completely independent two-port network analyzer and up to 16 modules can be added to a chassis for multi-site and multiport applications. All ports are fully synchronous so multiple ports can be measured simultaneously with multiport error correction applied. For more information, see page 28.

Achieve confidence and continuity in measurements

The M937xA extends Keysight's expertise in metrology to the modular form factor. It provides the same quality results you have come to expect in our vector network analyzers. Here are a few examples of ways that we continue to provide measurement quality and continuity.

- Dynamic range: > 114 dB at 9 GHz, > 110 dB at 20 GHz
- Trace noise: < 0.003 dB
- Sweep speed: 18 to 33 msec across 401 points
- Maximum leveled power: up to +7 dBm
- Stability: 0.005 dB/°C up to 4 GHz <0.02 dB/°C up to 26.5 GHz

- Electronic calibration (ECal): enables fast, easy and accurate calibrations

Maintain hardware compliance

The M937xA is PXI compliant and designed to benefit from fast data interfaces. The PXI VNA can be integrated with other test and automation modules in either a PXIe or Hybrid slot. The PXI format offers high performance in a small, rugged package. It is an ideal deployment platform for many automated test systems.



Pay for only the frequency range you need with the widest choice of frequency ranges from 300 kHz up to 26.5 GHz.

Easy integration into test environments

Software platform

Keysight soft front panels provide easy to use instrument communications. The graphical user interface guides developers through module setup using a similar look and feel as the popular PNA. Users can quickly configure the instrument parameters and perform calibrations.

IO Libraries

Keysight IO Libraries Suite offers fast and easy connection to both traditional and modular instruments. The Keysight IO Libraries Suite helps you by displaying all of the modules in your system, whether they are PXI, PXIe, or AXIe. From here you can view information about the installed software or launch the modules' soft front panel directly from Keysight Connection Expert (KCE). KCE offers an easy way to find the correct driver for your instrument.

Drivers

The M937xA PXI VNA is supplied with a comprehensive portfolio of module drivers, documentation, examples, and software tools to help you quickly develop test systems with your software platform of choice. The module comes with IVI-COM, IVI-C, LabVIEW and MATLAB software drivers that work in the most popular T&M development environments including, LabVIEW and LabWindows/CVI from National Instruments, MATLAB from The MathWorks, Microsoft C/ C++, C#, and VB.NET.

Easy software integration

To help you get started and complete complex tasks quickly, the module software support provides context sensitive help, complete documentation and code examples that allow quick module set up. These code examples can be easily modified, so that the PXI VNA can be

quickly integrated into a test system. Included are application code examples for LabVIEW, LabWindows/CVI, Visual Studio C, C++, and C#, Visual Basic, and MATLAB.

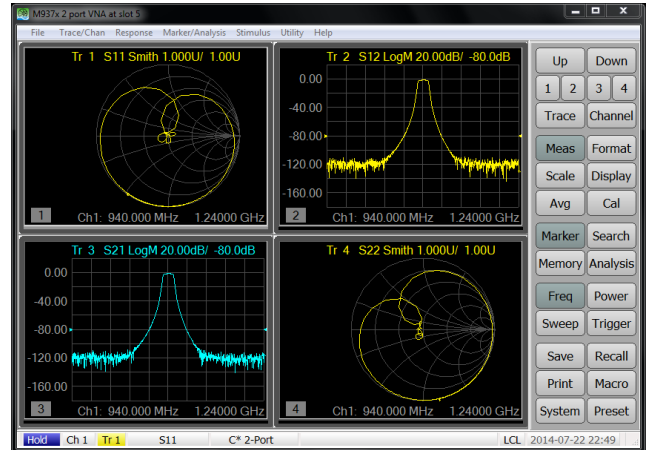

The graphical user interface guides test engineers using a similar look and feel as Keysight's popular PNA family of network analyzers

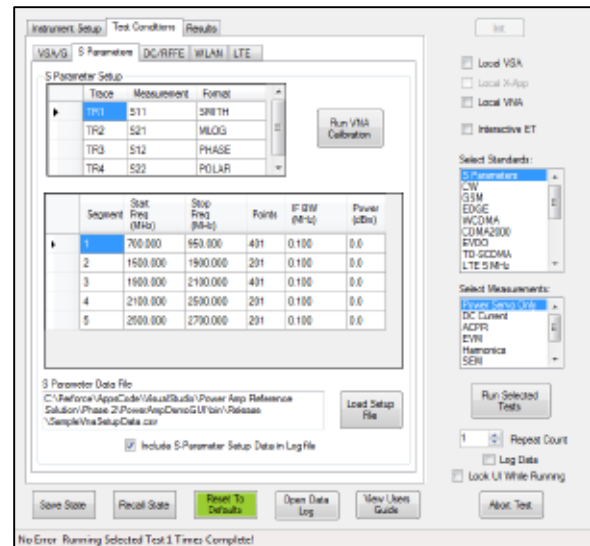

The PXI VNA's multiple programmatic interfaces allow for easy integration into test environments and reduced development time.

Table of Contents

Definitions.....	6
System Specifications.....	7
Table 1. Frequency Information	7
Table 2. Noise floor and dynamic range.....	8
Corrected performance	9
Table 3. With N4691B electronic calibration module.....	9
Table 4. With 85052D standard mechanical 3.5 mm calibration kit	11
Uncorrected System Performance	12
Table 5. Uncorrected error terms - specification.....	12
Test Port Output	13
Table 6. Maximum output port power	13
Table 7. Nominal power (preset power level)	13
Table 8. Power Range.....	13
Table 9. Power level accuracy.....	14
Table 10. Source harmonics.....	14
Table 11. Non-harmonic spurs	15
Table 12. Phase noise	15
Test Port Input	15
Table 13. Test port input damage level.....	15
Table 14. Receiver compression level for 0.1 dB compression (typical) ...	15
Table 15. Receiver compression versus test port power level (specified)	16
Table 16. Noise floor (10 Hz IF bandwidth).....	16
Table 17. Magnitude trace noise (1 kHz IF bandwidth, -5 dBm power)....	17
Table 18. Magnitude trace noise (characteristic performance, +6 dBm power).....	18
Table 19. Magnitude trace noise (typical performance, +6 dBm power) ..	18
Table 20. Phase trace noise (1 kHz IF bandwidth, -5 dBm power).....	18
Table 21. Phase trace noise (characteristic performance, +6 dBm power)	18
Table 22. Phase trace noise (typical performance, +6 dBm power)	18
Table 23. Temperature stability (typical)	19

Dynamic Accuracy.....	19
Table 24. Dynamic Accuracy 4 GHz to 26.5 GHz	19
General Information.....	21
Table 25. System requirements	21
Table 26. Environmental and Physical Specifications.....	22
Table 27. Regulatory and Safety Compliance.....	23
Table 28. Physical Size and Weight.....	23
Table 29. Electrical Power	24
Table 30. Front Panel Information	24
Table 31. Measurement speed (milliseconds)	26
Table 32. Measurement capabilities.....	28
Table 33. Software	31

Definitions

Specification (spec.)

Warranted performance. Specifications include guardbands to account for the expected statistical performance distribution, measurement uncertainties, and changes in performance due to environmental conditions. All specifications and characteristics apply over a $25^{\circ}\text{C} \pm 5^{\circ}\text{C}$ range ambient and module temperature between 33°C to 46°C (unless otherwise stated). The following conditions must be met:

- Instrument has been turned on for 60 minutes with PXI VNA application running.
- Instrument is within its calibration cycle.
- Instrument remains at a stable surrounding environment temperature (between -10°C to 55°C) for 60 minutes prior to turn-on.

Characteristic (char.)

A performance parameter that the product is expected to meet before it leaves the factory, but that is not verified in the field and is not covered by the product warranty. A characteristic includes the same guardbands as a specification.

Typical (typ.)

Expected performance of an average unit at a stable temperature between $25^{\circ}\text{C} \pm 5^{\circ}\text{C}$ for 60 minutes prior to turn-on and during operation; does not include guardbands. It is not covered by the product warranty. The instrument must be within its calibration cycle.

Nominal (nom.)

A general, descriptive term or design parameter. It is not tested, and not covered by the product warranty.

Calibration

The process of measuring known standards to characterize an instrument's systematic (repeatable) errors.

Corrected (residual)

Indicates performance after error correction (calibration). It is determined by the quality of calibration standards and how well "known" they are, plus system repeatability, stability, and noise.

Uncorrected (raw)

Indicates instrument performance without error correction. The uncorrected performance affects the stability of a calibration

Temperatures referred to in this document are defined as follows:

- Full temperature range = individual module temperature of 10°C to 70°C , as reported by the module, and environment temperature of 0°C to 55°C .
- Controlled temperature range = individual module temperature of 33°C to 46°C , as reported by the module, and environment temperature of 20°C to 30°C .

Frequency break points

For all tables in this data sheet, the specified performance at the exact frequency of a break is the degraded value of the two specifications at that frequency, unless otherwise indicated.

Block diagram

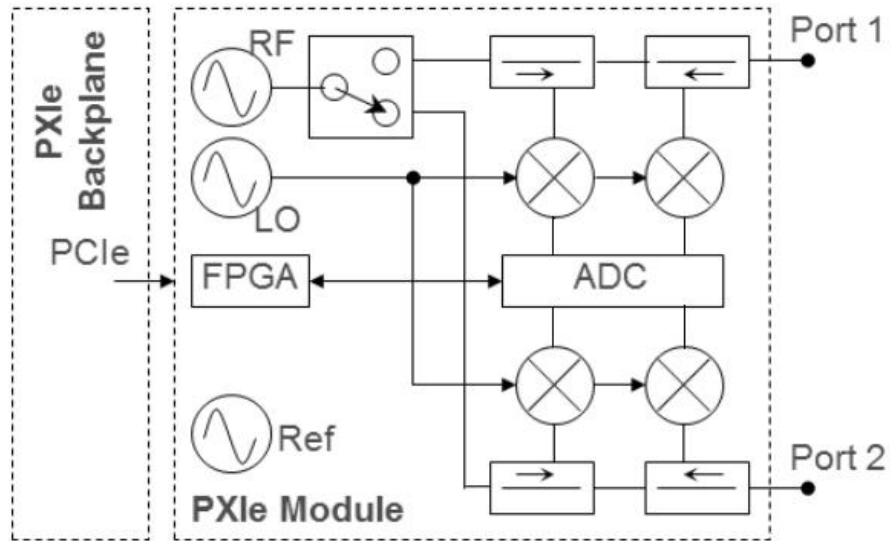

PXIe Vector Network Analyzer block diagram

System Specifications

Table 1. Frequency Information

Frequency Range	
Model Number	Frequency Range
M9370A	300 kHz to 4 GHz
M9371A	300 kHz to 6.5 GHz
M9372A	300 kHz to 9 GHz
M9373A	300 kHz to 14 GHz
M9374A	300 kHz to 20 GHz
M9375A	300 kHz to 26.5 GHz
Frequency Resolution	
Frequency Range	Specification
300 kHz to 2.5 GHz	1 Hz
> 2.5 to 5 GHz	2 Hz
> 5 to 10 GHz	3 Hz
> 10 to 20 GHz	6 Hz
> 20 GHz	12 Hz

Frequency Reference	Specification	Typical
Accuracy	±1 ppm	
Aging rate		< 3.5 ppm/year
Temperature stability		±1 ppm over 0 to 55 °C
System impedance	50 Ω (nominal)	75 Ω with appropriate adapter and calibration kit

Table 2. Noise floor and dynamic range

Frequency range	Noise Floor ¹ (dBm) (specification)	Dynamic Range ² (dB) (specification)	Dynamic Range ³ (dB) (typical)	Effective Dynamic Range ⁴ (dB) (characteristic)
300 kHz to < 10 MHz	--	--	111	97
10 to < 250 MHz	-98	98	110	95
250 MHz to 1 GHz	-108	115	122	114
> 1 to 4 GHz	-108	115	122	115
> 4 to 6.5 GHz	-108	115	122	115
> 6.5 to 9 GHz	-108	114	121	114
> 9 to 14 GHz	-108	114	120	110
> 14 to 18 GHz	-108	112	119	100
> 18 to 20 GHz	-108	110	118	98
> 20 to 24 GHz	-98	95	104	82
> 24 to 26.5 GHz	--	--	95	65

¹ Noise floor in a 10 Hz IF bandwidth

² System dynamic range = source maximum output power minus receiver noise floor at 10 Hz IF bandwidth. Does not include single module crosstalk effects.

³ System dynamic range = source maximum output power minus receiver noise floor at 10 Hz IF bandwidth. Does not include single module crosstalk effects.

⁴ Effective dynamic range is when the crosstalk is greater than the noise floor, and thus crosstalk limits the dynamic range. Crosstalk only limits the dynamic range for IF bandwidths < 1 kHz.

Custom Uncertainty Calculator

This document provides technical specifications for the corrected performance of the PXI VNA using either the N4691B Electronic Calibration Module, or the 85052D Standard Mechanical Calibration Kit. To determine transmission and reflection uncertainty curves with other calibration kits, please download our free Uncertainty Calculator from http://www.keysight.com/find/na_calculator to generate the curves for your specific calibration kit.

Corrected performance

Table 3. With N4691B electronic calibration module⁵

Corrected error terms (dB) - 300 kHz to 24 GHz

Frequency	Directivity	Source match	Load match	Transmission tracking		Reflection tracking	
				Mag	Phase °	Mag	Phase °
300 kHz to < 2 MHz	31	29	28	±0.195	±1.289	±0.110	±0.726
2 MHz to 1 GHz	52	47	47	±0.022	±0.145	±0.020	±0.132
> 1 to 2 GHz	52	47	47	±0.022	±0.148	±0.020	±0.132
> 2 to 4 GHz	48	45	44	±0.036	±0.238	±0.030	±0.198
> 4 to 6.5 GHz	48	45	44	±0.040	±0.262	±0.030	±0.198
> 6.5 to 9 GHz	48	45	43	±0.042	±0.279	±0.030	±0.198
> 9 to 14 GHz	46	42	40	±0.059	±0.392	±0.040	±0.264
> 14 to 20 GHz	46	42	40	±0.062	±0.407	±0.040	±0.264
> 20 to 24 GHz	44	40	37	±0.084	±0.556	±0.050	±0.330

⁵ Measured with 10 Hz IF bandwidth, no averaging applied to data, environmental temperature = 23 °C (±3 °C) with < 1 °C deviation from calibration temperature, isolation calibration performed.

Transmission uncertainty (*magnitude and phase*)

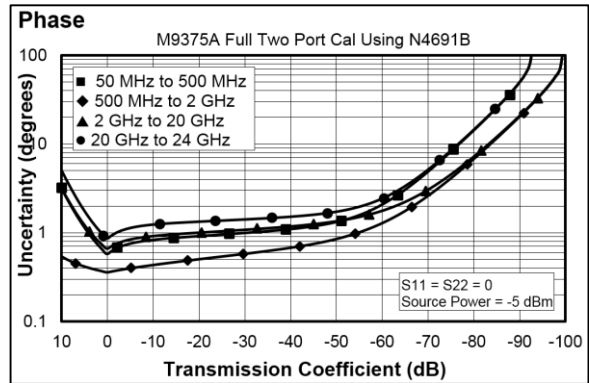
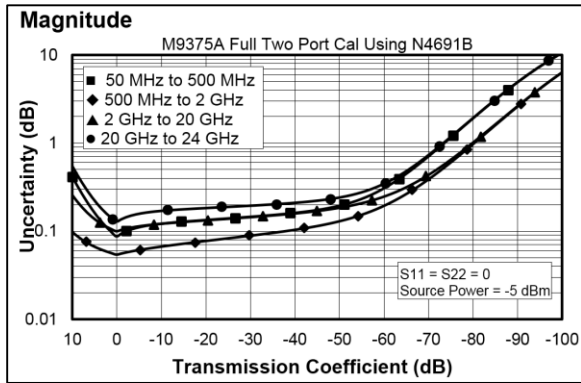

Reflection uncertainty (*magnitude and phase*)

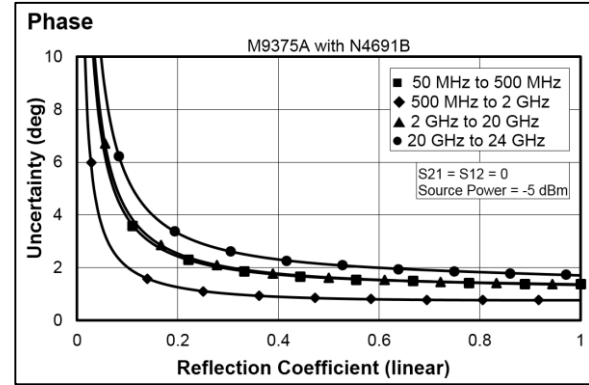
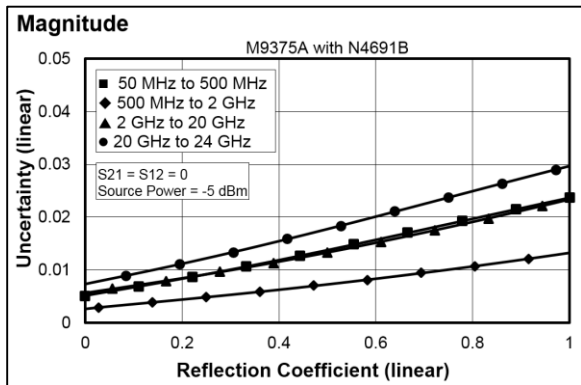
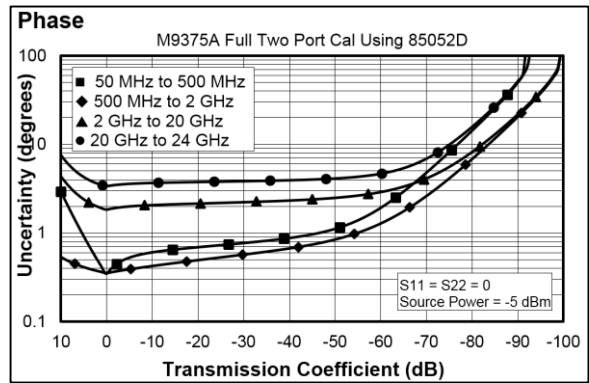
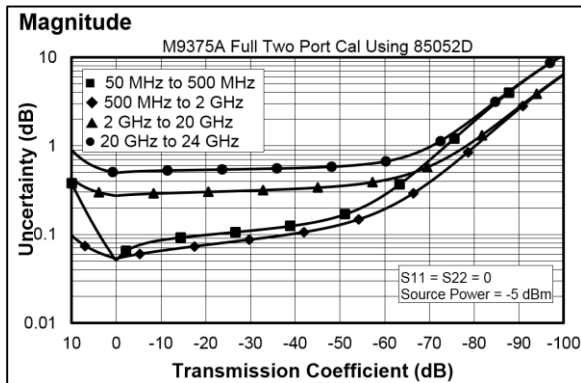

Table 4. With 85052D standard mechanical 3.5 mm calibration kit ⁶

Corrected error terms (dB) – 300 kHz to 24 GHz

Frequency	Directivity	Source match	Load match	Transmission tracking		Reflection tracking	
				Mag	Phase °	Mag	Phase °
300 kHz to < 2 MHz	42	37	42	±0.068	±0.450	±0.003	±0.020
2 MHz to 1 GHz	42	37	42	±0.019	±0.123	±0.003	±0.020
> 1 to 2 GHz	42	37	42	±0.021	±0.136	±0.003	±0.020
> 2 to 4 GHz	38	31	38	±0.055	±0.361	±0.004	±0.027
> 4 to 6.5 GHz	38	31	38	±0.089	±0.584	±0.004	±0.027
> 6.5 to 9 GHz	36	28	36	±0.155	±1.023	±0.008	±0.052
> 9 to 14 GHz	36	28	36	±0.195	±1.286	±0.008	±0.052
> 14 to 20 GHz	36	28	36	±0.233	±1.536	±0.008	±0.052
> 20 to 24 GHz	30	25	30	±0.442	±2.915	±0.011	±0.072

Transmission uncertainty (*magnitude and phase*)



⁶ Measured with 10 Hz IF bandwidth, no averaging applied to data, environmental temperature = 23 °C (±3 °C) with < 1 °C deviation from calibration temperature, isolation calibration performed.

Reflection uncertainty (magnitude and phase)

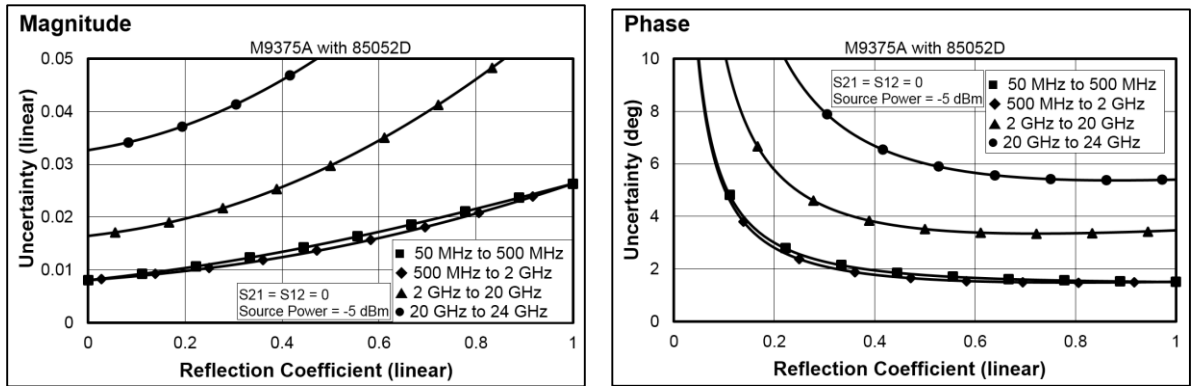

Uncorrected System Performance

Specifications apply to following conditions:

- Over environmental temperature of $25\text{ }^{\circ}\text{C} \pm 5\text{ }^{\circ}\text{C}$,
- Cable loss not included in transmission tracking.
- Cross-talk measurement conditions: normalized to a thru, measured with shorts on all ports, 10 Hz IF bandwidth, averaging factor of 8, alternate mode, source power set to the specified maximum power.

Table 5. Uncorrected error terms - specification

Frequency	Directivity (specified)	Source match (specified)	Load match (specified)	Transmission tracking (typical)	Reflection tracking (typical)	Cross-talk (typical)
300 kHz to < 2 MHz	9	9	9	± 2	± 2	97
2 MHz to 1 GHz	21	19	21	± 2	± 2	95
> 1 to 2 GHz	21	20	19	± 2	± 2	123
> 2 to 4 GHz	21	20	15	± 2	± 2	121
> 4 to 6.5 GHz	20	15	11	± 2	± 2	121
> 6.5 to 9 GHz	11	11	9	± 2	± 2	119
> 9 to 14 GHz	9	9	7	± 2	± 2	110
> 14 to 20 GHz	4	6	6	± 2	± 2	98
> 20 to 24 GHz	3	5	4	± 2.5	± 2.5	82

Test Port Output

Table 6. Maximum output port power

Frequency Range	Specification	Typical
300 kHz to < 10 MHz	--	+3 dBm
10 to < 250 MHz	0 dBm	+3 dBm
250 MHz to 6.5 GHz	+7 dBm	+10 dBm
> 6.5 to 9 GHz	+6 dBm	+9 dBm
> 9 to 14 GHz	+6 dBm	+8 dBm
> 14 to 18 GHz	+4 dBm	+7 dBm
> 18 to 20 GHz	+2 dBm	+6 dBm
> 20 to 24 GHz	-3 dBm	+1 dBm
> 24 to 26.5 GHz	--	-5 dBm

Table 7. Nominal power (preset power level)

Model	Specification
All models	-5 dBm

Table 8. Power Range

Frequency Range	Specification	Typical
300 kHz to < 10 MHz	--	+3 dBm to -40 dBm
10 to < 250 MHz	0 dBm to -40 dBm	
250 MHz to 6.5 GHz	+7 to -40 dBm	
> 6.5 to 9 GHz	+6 to -40 dBm	
> 9 to 14 GHz	+6 to -40 dBm	
> 14 to 18 GHz	+4 to -40 dBm	
> 18 to 20 GHz	+2 to -40 dBm	
> 20 to 24 GHz	-3 to -40 dBm	
> 24 to 26.5 GHz	--	-5 to -40 dBm

Table 9. Power level accuracy

Power level range				
Frequency range	Specification		Typical	
	-40 dBm ≤ P < -30 dBm	-30 dBm ≤ P < max port spec power	-40 dBm ≤ P < -30 dBm	-30 dBm ≤ P < max port spec power
300 kHz to < 2 MHz	--	--	±1.3	±1.0
2 to < 10 MHz	--	--	±2.5	±2.2
10 to < 250 MHz	±4.5	±2.5	±1.0	±0.7
250 MHz to 1 GHz	±1.5	±1.5	±0.4	±0.4
> 1 to 6.5 GHz	±1.5	±1.5	±0.3	±0.3
> 6.5 to 20 GHz	±1.5	±1.5	±0.5	±0.5
> 20 to 24 GHz	±3.0	±3.0	±0.8	±0.8
> 24 to 26.5 GHz	--	--	±1.8	±1.8
Programmable power resolution			0.01 dB typical	

Table 10. Source harmonics⁷

Frequency Range	Specification	Typical
300 kHz to < 100 MHz	--	-6 dBc
100 MHz to 2 GHz	--	-6 dBc
> 4 to 6.5 GHz	--	-11 dBc
> 6.5 to 14 GHz	--	-14 dBc
> 14 to 20 GHz	--	-8 dBc
> 20 to 26.5 GHz	--	-5 dBc

⁷ At maximum specified power, includes sub-harmonics.

Table 11. Non-harmonic spurs⁸

Frequency Range	Specification	Typical
300 kHz to < 10 MHz	--	-44 dBc
10 MHz to 10 GHz	--	-36 dBc
> 10 to 20 GHz	--	-30 dBc
> 20 to 26.5 GHz	--	-24 dBc

Table 12. Phase noise⁹

Frequency Range	Specification	Typical
300 kHz to < 2 MHz	--	-100 dBc/Hz
2 MHz to 2.5 GHz	--	-90 dBc/Hz
> 2.5 to 5 GHz	--	-84 dBc/Hz
> 5 to 10 GHz	--	-78 dBc/Hz
> 10 to 20 GHz	--	-72 dBc/Hz
> 20 to 26.5 GHz	--	-66 dBc/Hz

Test Port Input

Table 13. Test port input damage level

Frequency Range	Specification
300 kHz to 26.5 GHz	> +20 dBm, > ±35 VDC, > 1000V ESD

Table 14. Receiver compression level for 0.1 dB compression (typical)

Frequency Range	Specification	Typical
300 kHz to < 10 MHz	--	> +7 dBm
10 to < 250 MHz	--	> +8 dBm
250 MHz to 1 GHz	--	> +12 dBm
> 1 to 4 GHz	--	> +10 dBm
> 4 to 6.5 GHz	--	> +8 dBm

⁸ At nominal (preset) power of -5 dBm.

⁹ Phase noise in dBc/Hz, for output ports 1 or 2; typical values for 1 kHz, 10 kHz, and 100 kHz offsets.

> 6.5 to 9 GHz	--	> +8 dBm
> 9 to 14 GHz	--	> +6 dBm
> 14 to 18 GHz	--	> +5 dBm
> 18 to 20 GHz	--	> +10 dBm
> 20 to 24 GHz	--	> +8 dBm
> 24 to 26.5 GHz	--	> +4 dBm

Table 15. Receiver compression versus test port power level (specified)

Frequency	Test port power level (dBm)	Magnitude (dB)	Phase (degrees)
10 MHz to 250 MHz	0	.15	1.1
> 250 MHz to 1 GHz	7	.12	.9
> 1 to 2 GHz	7	.12	.6
> 2 to 4 GHz	7	.12	.7
> 4 to 6.5 GHz	7	.12	.9
> 6.5 to 9 GHz	6	.12	1.0
> 9 to 14 GHz	6	.16	1.3
>14 to 18 GHz	4	.16	1.5
>18 to 20 GHz	2	.13	1.6
>20 to 24 GHz	-3	.11	1.0

Table 16. Noise floor (10 Hz IF bandwidth)

Frequency Range	Specification	Typical
300 kHz to < 10 MHz	--	-108 dBm
10 to < 250 MHz	-98 dBm	-107 dBm
250 MHz to 1 GHz	-108 dBm	-112 dBm
> 1 to 4 GHz	-108 dBm	-112 dBm
> 4 to 6.5 GHz	-108 dBm	-112 dBm
> 6.5 to 9 GHz	-108 dBm	-112 dBm
> 9 to 14 GHz	-108 dBm	-112 dBm
> 14 to 20 GHz	-108 dBm	-112 dBm
> 20 to 24 GHz	-98 dBm	-103 dBm
> 24 to 26.5 GHz	--	-100 dBm

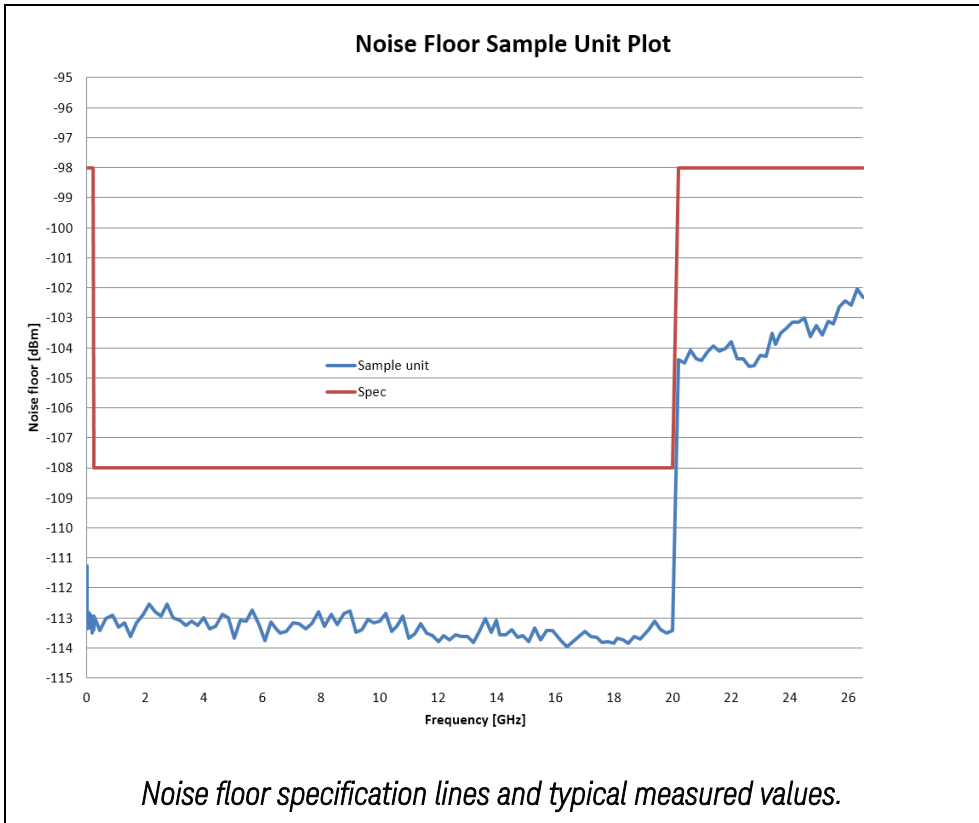

Table 17. Magnitude trace noise (1 kHz IF bandwidth, -5 dBm power)

Frequency Range	Specification	Typical
300 kHz to < 10 MHz	--	0.0020 dB rms
10 MHz to 4 GHz	0.003 dB rms	0.0010 dB rms
> 4 to 6.5 GHz	0.003 dB rms	0.0010 dB rms
> 6.5 to 9 GHz	0.003 dB rms	0.0010 dB rms
> 9 to 14 GHz	0.003 dB rms	0.0010 dB rms
> 14 to 20 GHz	0.003 dB rms	0.0010 dB rms
> 20 to 24 GHz	0.006 dB rms	0.0015 dB rms
> 24 to 26.5 GHz	--	0.0020 dB rms

Table 18. Magnitude trace noise (characteristic performance, +6 dBm power)

Frequency Range	10 kHz IF bandwidth	100 kHz IF bandwidth	600 kHz IF bandwidth
250 MHz to 10 GHz	0.0020 dB rms	0.0055 dB rms	0.0120 dB rms
> 10 to 14 GHz	0.0030 dB rms	0.0075 dB rms	0.0160 dB rms

Table 19. Magnitude trace noise (typical performance, +6 dBm power)

Frequency Range	10 kHz IF bandwidth	100 kHz IF bandwidth	600 kHz IF bandwidth
250 MHz to 10 GHz	0.001 dB rms	0.003 dB rms	0.007 dB rms
> 10 to 14 GHz	0.002 dB rms	0.004 dB rms	0.008 dB rms

Table 20. Phase trace noise (1 kHz IF bandwidth, -5 dBm power)

Description	Specification	Typical value
300 kHz to < 10 MHz	--	0.020 deg
10 MHz to 4 GHz	0.030 deg	0.010 deg
> 4 to 6.5 GHz	0.030 deg	0.010 deg
> 6.5 to 9 GHz	0.030 deg	0.010 deg
> 9 to 14 GHz	0.030 deg	0.010 deg
> 14 to 20 GHz	0.030 deg	0.010 deg
> 20 to 24 GHz	0.060 deg	0.015 deg
> 24 to 26.5 GHz	--	0.020 deg

Table 21. Phase trace noise (characteristic performance, +6 dBm power)

Frequency Range	10 kHz IF bandwidth	100 kHz IF bandwidth	600 kHz IF bandwidth
250 MHz to 10 GHz	0.010 deg.	0.025 deg.	0.060 deg.
> 10 to 14 GHz	0.020 deg.	0.055 deg.	0.120 deg.

Table 22. Phase trace noise (typical performance, +6 dBm power)

Frequency Range	10 kHz IF bandwidth	100 kHz IF bandwidth	600 kHz IF bandwidth
250 MHz to 10 GHz	0.006 deg.	0.014 deg.	0.033 deg.
> 10 to 14 GHz	0.010 deg.	0.030 deg.	0.060 deg.

Table 23. Temperature stability (typical)

Frequency range	Magnitude stability	Phase stability
300 kHz to < 10 MHz	±0.005 dB/°C	±0.20 Degree/°C
10 MHz to 4 GHz	±0.005 dB/°C	±0.10 Degree/°C
> 4 to 6.5 GHz	±0.010dB/°C	±0.15 Degree/°C
> 6.5 to 9 GHz	±0.015 dB/°C	±0.20 Degree/°C
> 9 to 14 GHz	±0.015 dB/°C	±0.40 Degree/°C
> 14 to 20 GHz	±0.020 dB/°C	±0.50 Degree/°C
> 20 to 26.5 GHz	±0.020 dB/°C	±0.60 Degree/°C

Dynamic Accuracy

Table 24. Dynamic Accuracy 4 GHz to 26.5 GHz

Accuracy of the test port input power relative to the reference input power level.

Although labeled 'M9375A', these graphs apply to all models.

Dynamic accuracy, 4 GHz (*magnitude and phase*)

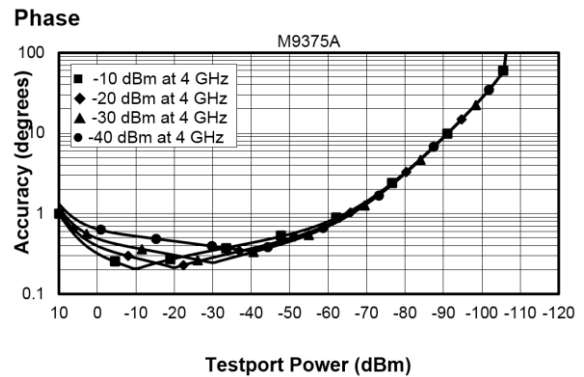
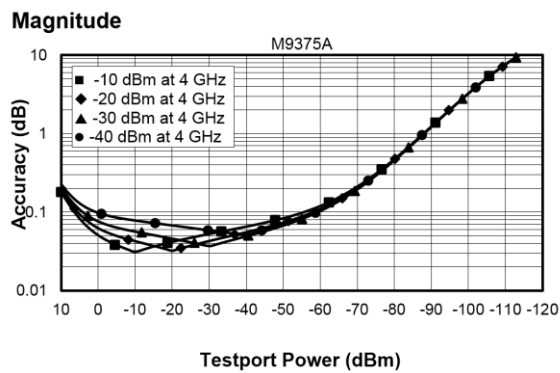

Dynamic accuracy, 6.5 GHz (*magnitude and phase*)

Magnitude

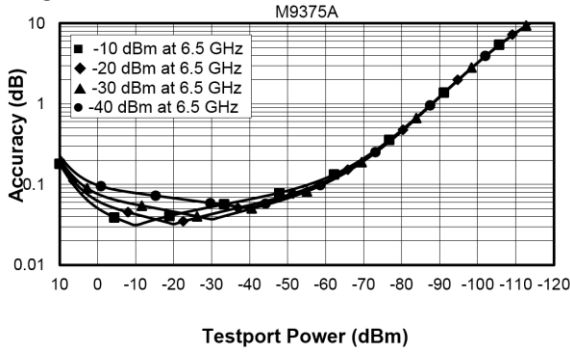

Phase

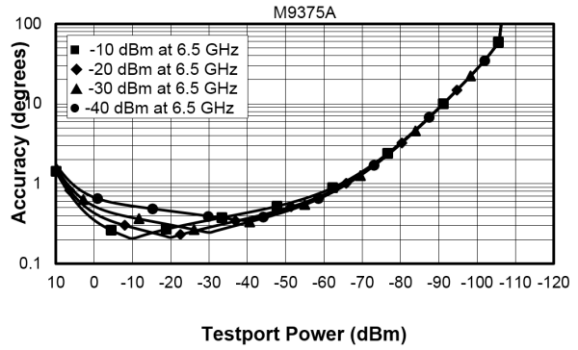

Dynamic accuracy, 9 GHz (*magnitude and phase*)

Magnitude

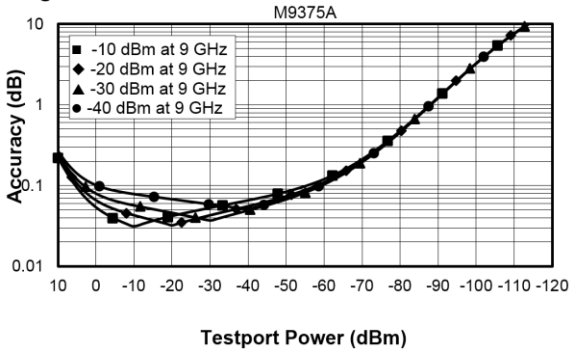

Phase

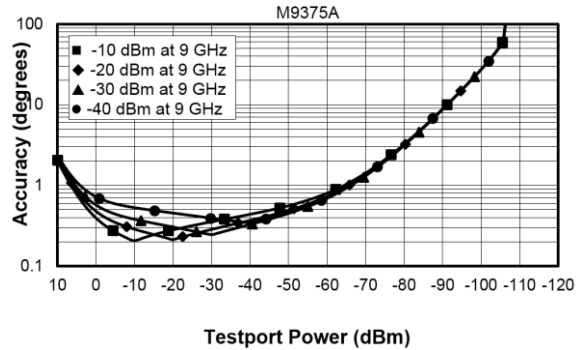

Dynamic accuracy, 14 GHz (*magnitude and phase*)

Magnitude

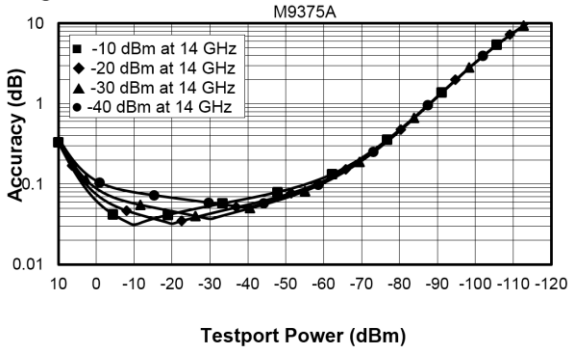

Phase

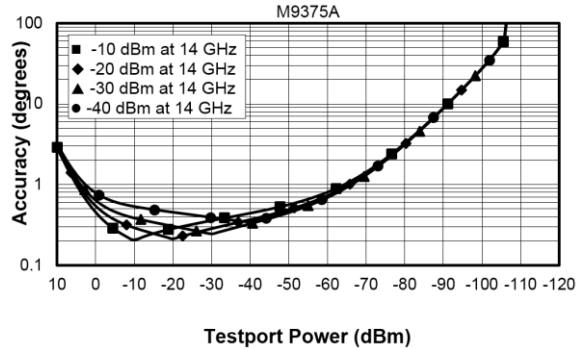

Dynamic accuracy, 20 GHz (magnitude and phase)

Magnitude

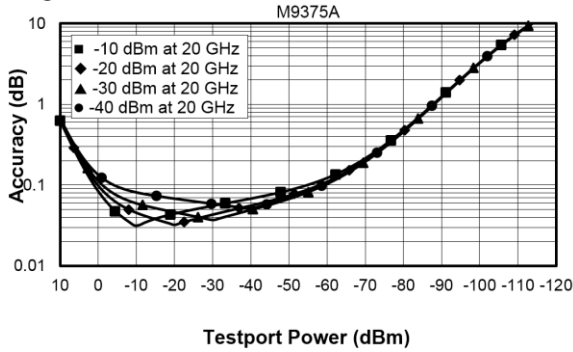

Phase

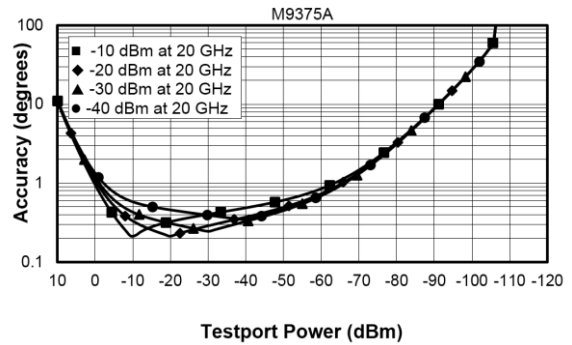

Dynamic accuracy, 26.5 GHz (magnitude and phase)

Magnitude

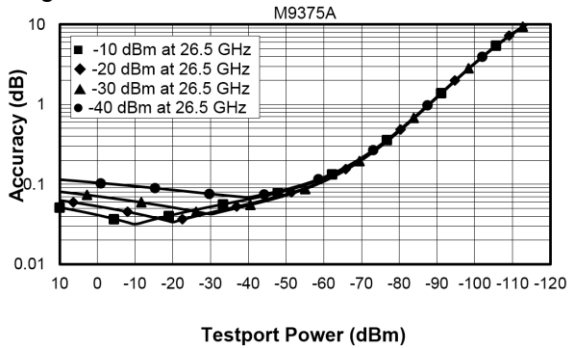

Phase

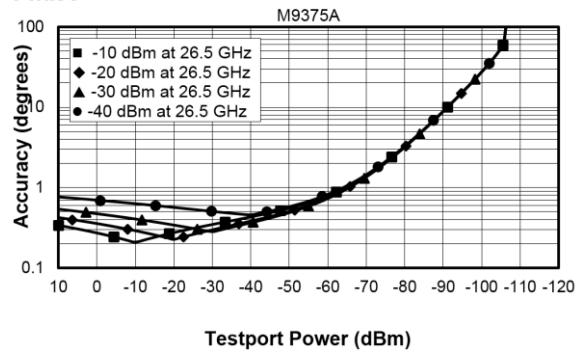

General Information

Table 25. System requirements

Processor requirement	
Hardware requirements	M9037A PXIe High performance embedded controller recommended
Operating systems	Windows 7 or Windows Vista, SP1&2 (32 & 64 bit)
Processor speed	2.4 GHz recommended; 1.5 GHz dual core (x86 or x64) minimum
Available memory	8 GB recommended; 1 GB minimum
Available disk space	1.5 GB available hard disk space minimum
Instrument drivers	
Keysight IO libraries	Version 16.3.17914.4 or later The latest Keysight IO library suite is available at: www.keysight.com/find/iosuite

Table 26. Environmental and Physical Specifications

Description	Samples of this product have been type tested in accordance with the Keysight Environmental Test Manual and verified to be robust against the environmental stresses of Storage, Transportation and End-use; those stresses include, but are not limited to, temperature, humidity, shock, vibration, altitude, and power line conditions. Test Methods are aligned with IEC 60068-2 and levels are similar to MIL-PRF-28800F Class 3.	
Temperature	Operating	0 to 55 °C ambient 10 to 70 °C module temperature
	Non-operating	-40 to +70 °C
Humidity	Type tested at 95%, +40 °C (non-condensing)	
Altitude – Operating	Up to 15,000 feet (4,572 meters)	
Altitude – Non-operating	Up to 15,000 feet (4,572 meters)	
Intrusion protection	IP 30 IEC/EN 60529	
Warm-up time	60 minutes	
Connectors	RF In and RF Out	3.5 mm female
	LO In and LO Out	SMA female
	Trig. In and Trig. Out, Trig. Ready	SMB female

Table 27. Regulatory and Safety Compliance

EMC	
	<p>Complies with European EMC Directive 2014/30/EU</p> <ul style="list-style-type: none"> ▪ IEC/EN 61326-1 ▪ CISPR Pub 11 Group 1, class A ▪ AS/NZS CISPR 11 ▪ ICES/NMB-001 <p>This ISM device complies with Canadian ICES-001. Cet appareil ISM est conforme a la norme NMB-001 du Canada.</p> <ul style="list-style-type: none"> ▪ South Korean Class A EMC declaration: This equipment is Class A suitable for professional use and is for use in electromagnetic environments outside of the home. <p>A급 기기 (업무용 방송통신기자재)</p> <p>이 기기는 업무용(A급) 전자파적합기기로서 판매자 또는 사용자는 이 점을 주의하시기 바라며, 가정외의 지역에서 사용하는 것을 목적으로 합니다.</p>
Safety	
	<p>Acoustic statement (European Machinery Directive 2006/42/EC, 1.7.4.2u)</p> <ul style="list-style-type: none"> ▪ Acoustic noise emission ▪ LpA <70 dB ▪ Operator position ▪ Normal operation mode
Instrument calibration cycle	
	1 Year

Table 28. Physical Size and Weight

Size	M937xA	1 PXIe slot Compatible with PXI Hybrid slots
Dimensions		
Width	19.9 mm (0.784 in.)	Exclusive of the back plane connector alignment tabs, and front panel ground clip in free state
Height	128.4 mm (5.06 in.)	Exclusive of the ejector hook
Depth	212.6 mm (8.37 in.)	From tip of ejector to tip of backplane connector
Weight	M937xA	0.59 kg (1.3 lbs)

Table 29. Electrical Power

Total Power Dissipation	M937xA	23 watts (maximum)		
Supply voltage	+3.3 V	+5 V	+12 V	-12 V
Nominal current	0.72 amps.	0 amps.	1.7 amps	0 amps.

Table 30. Front Panel Information

Description	General characteristics	Typical
Test ports - RF port 1 or port 2		
Connector	3.5 mm female	
Impedance	50 Ω (nominal)	
Damage level	> +20 dBm, > ± 35 VDC, 1000 Volts ESD	
LO ports - LO In & LO Out		
Connector	SMA female	
Impedance	50 Ω (nominal)	
Damage level	> +5 dBm, ± 35 VDC, 1000 Volts ESD	
External reference input		
Connector	SMB	
Input frequency	10 MHz	
Input amplitude range	-15 dBm to +5 dBm (nominal)	
Impedance	50 Ω (nominal), AC coupled	
Lock range	± 10 ppm of external reference frequency (nominal)	
External reference out		
Connector	SMB	
Output frequency	10 MHz	
Output amplitude	+10 dBm	
Impedance	50 Ω (nominal), AC coupled	
Trigger input		
Connector	SMB	
Trigger type	Edge	
Impedance	1 K Ω (nominal), DC coupled	

Description	General characteristics	Typical
Level range		3.3V TTL
Rising edge		1.7 V (nominal)
Falling edge		1 V (nominal)
Trigger Out		
Connector	SMB	
Level range		3.3V TTL
Ready For trigger out		
Connector	SMB	
Impedance		50 Ω (nominal), DC coupled
Level range		3.3V TTL

Table 31. Measurement speed (milliseconds)¹⁰

Description	Typical				
Typical cycle time (0.8 – 1.8 GHz frequency span, 1 kHz IF bandwidth, includes data transfer)					
Number of points	201	401	801	1601	16001
Uncorrected	211	415	830	1654	16488
2-port calibration	423	836	1661	3308	33013
4-port calibration	842	1670	3322	6630	66175
Typical cycle time (0.8 – 1.8 GHz frequency span, 100 kHz IF bandwidth, includes data transfer)					
Number of points	201	401	801	1601	16001
Uncorrected	8.5	14	25	46	421
2-port calibration	17.5	28.5	50	92	1012
4-port calibration	35.0	57.8	104	198	1844
Typical cycle time (0.8 – 1.8 GHz frequency span, 600 kHz IF bandwidth, includes data transfer)					
Number of points	201	401	801	1601	16001
Uncorrected	6.0	8.9	16.2	29.2	258
2-port calibration	11.9	17.6	32.4	58.7	686
4-port calibration	23.3	36.0	63.1	118	1050
Typical cycle time (full frequency span, 100 kHz IF bandwidth, no calibration, includes data transfer)					
Number of points	201	401	801	1601	16001
M9370A 300 kHz to 4 GHz	15.0	22.0	35.0	59.0	461
M9371A 300 kHz to 6.5 GHz	15.1	22.6	36.3	61.9	499
M9372A 300 kHz to 9 GHz	15.2	22.9	37.1	64.3	526
M9373A 300 kHz to 14 GHz	16.2	24.7	40.4	70.3	584
M9374A 300 kHz to 20 GHz	17.0	25.7	42.3	74.0	621
M9375A 300 kHz to 26.5 GHz	18.0	27.5	46.0	80.2	683

¹⁰ Measured using a Keysight M9018A PXIe chassis, and an M9036A dual-core embedded controller running Windows 7, with firmware revision A.01.00. Data transfer includes real and imaginary pairs, and includes transferring four S-parameters for both the 2-port and 4-port calibrations. Uncorrected measurements are for one sweep direction and transferring the corresponding two S-parameters. Measured with normal sweep mode; the fast sweep mode will have faster measurement speeds.

Measurement speed continued

Typical cycle time (full frequency span, 600 kHz IF bandwidth, no calibration, includes data transfer)					
Number of points	201	401	801	1601	16001
M9370A 300 kHz to 4 GHz	11.5	15.6	22.9	35.6	273
M9371A 300 kHz to 6.5 GHz	11.8	16.0	23.6	37.2	279
M9372A 300 kHz to 9 GHz	11.9	16.1	23.8	37.9	284
M9373A 300 kHz to 14 GHz	12.1	17.0	25.4	40.9	304
M9374A 300 kHz to 20 GHz	12.3	17.4	26.4	42.6	318
M9375A 300 kHz to 26.5 GHz	12.7	18.3	27.9	45.6	347

Typical cycle time (full frequency span, 100 kHz IF bandwidth, 2-port calibration, includes data transfer)					
Number of points	201	401	801	1601	16001
M9370A 300 kHz to 4 GHz	28.7	42.7	68.2	116	1154
M9371A 300 kHz to 6.5 GHz	29.8	44.8	72.3	125	1272
M9372A 300 kHz to 9 GHz	30.3	45.8	74.5	129	1448
M9373A 300 kHz to 14 GHz	32.4	49.7	80.9	141	1633
M9374A 300 kHz to 20 GHz	33.5	51.8	84.7	148	2000
M9375A 300 kHz to 26.5 GHz	35.2	54.8	91.1	161	2242

Typical cycle time (full frequency span, 600 kHz IF bandwidth, 2-port calibration, includes data transfer)					
Number of points	201	401	801	1601	16001
M9370A 300 kHz to 4 GHz	22.7	30.9	45.7	71.0	705
M9371A 300 kHz to 6.5 GHz	23.3	32.3	47.7	74.3	733
M9372A 300 kHz to 9 GHz	23.6	32.3	47.9	75.9	757
M9373A 300 kHz to 14 GHz	24.1	34.0	51.3	81.9	832
M9374A 300 kHz to 20 GHz	24.8	35.0	53.1	85.3	936
M9375A 300 kHz to 26.5 GHz	25.3	36.6	55.6	91.1	1036

Typical cycle time (full frequency span, 600 kHz IF bandwidth, 4-port calibration, includes data transfer)					
Number of points	201	401	801	1601	16001
M9370A 300 kHz to 4 GHz	45.9	64.0	97.2	156	1129
M9371A 300 kHz to 6.5 GHz	47.0	66.3	100	162	1178
M9372A 300 kHz to 9 GHz	47.5	67.6	101	166	1216
M9373A 300 kHz to 14 GHz	48.9	70.5	108	178	1328
M9374A 300 kHz to 20 GHz	51.2	73.5	112	185	1410
M9375A 300 kHz to 26.5 GHz	52.1	76.7	120	198	1530

Table 32. Measurement capabilities

Multiport / Multisite operation

Please refer to the relevant literature for more information on Multiport/Multisite operation. The installation guide and help file are on the CD that was shipped with the PXI module and at:

<http://na.support.keysight.com/pxi/help>

- Ordering information:
<http://literature.cdn.keysight.com/litweb/pdf/5991-4885EN.pdf>
- Hardware configuration: Installation Guide
- Software configuration: M937xA Help file.

Multiport (Option 551)

The PXI VNA modules have the ability to be configured into a multiport network analyzer. Adding a second module to the PXI chassis would enable a four port vector network analyzer, and for each subsequent PXI VNA module which is added, it provides two additional test ports to the VNA. This configuration provides a full featured multiport vector network analyzer capability with full crossbar S-parameter measurement capability.

Configurations of up to 16 modules with 32 test ports have been demonstrated.

For four-port operation, all specifications apply except cross-module trace noise. Cross-module trace noise cannot be tested on individual modules. However, four-port trace noise performance will typically meet the two-port specifications.

Modules are designed and characterized to allow multiport operation beyond four ports, but performance is not warranted.

Multisite operation

Multi-site operation is the ability to configure multiple independent PXI VNAs to operate independently in a single PXIe chassis. Up to ten independent PXI VNA instances have been demonstrated, allowing parallel testing of devices. Each instance of an independent PXI VNA can have different number of ports, and can be triggered synchronously, or asynchronously.

More than four independent PXI VNAs operating on a single controller may experience some degradation in performance due to processing limitations.

With up to ten independent VNA instances, there is a limitation of a maximum of 100,001 total data points.

Description	Information
Data points	32,001
Measurements	S11, S21, S12 and S22 magnitude and phase Full S-parameter matrix for multiport operation
Formats	
Data display formats	Log magnitude, linear magnitude, VSWR, phase, group delay, impedance, real and imaginary
Channels	

Number of channels	Up to 4 independent measurement channels. A measurement channel is coupled to stimulus response settings including frequency, IF bandwidth, power level and number of points.
IF bandwidths	
	10 Hz, 20 Hz, 30 Hz, 50 Hz, 100 Hz, 200 Hz, 300 Hz, 500 Hz, 1 kHz, 2 kHz, 3 kHz, 5 kHz, 10 kHz, 20 kHz, 30 kHz, 50 kHz, 100 kHz, 300 kHz, 600 kHz, 1.2 MHz
Group delay	
Aperture (selectable)	(frequency span)/(number of points -1)
Maximum aperture	25% of frequency span
Minimum delay	Limited to measuring no more than 180° of phase change within the minimum aperture.
Display range	
Log magnitude S11 or S22	-1000 to 1000 dB
Log magnitude S21 or S12	-1000 to 1000 dB
Log magnitude resolution	0.01 dB
Phase	-180 to +180 degrees
Phase resolution	0.01 degrees
VSWR	1.01 to 1000
VSWR resolution	0.01
Display controls	Can specify scale, reference level and reference position
Averaging	
Averaging	2 to 999 - Averages vector data on each successive sweep or by point
Trace smoothing	Computes the moving average of adjacent data points. Smoothing aperture defines the trace width (number of points) to be averaged, and ranges from 0.25% to 20% of the trace width.
Traces	
Number of traces	Maximum 24 traces / window
Markers	
Data markers	Each trace can have up to 10 independent markers that can be displayed simultaneously. Delta markers are available for each marker.
Marker formats	Default marker format is the trace format. In Smith chart or polar format, [Real +Imag] or [Mag and Phase] formats are also available.
Marker functions	Peak, Next Peak, Peak Left, Peak Right, Mkr→ Center, Min Search, Peak Excursion, Peak Threshold
Sweep	
Sweep type	Linear, Log, Power, Segment

Sweep time	Set sweep time in seconds
Sweep trigger modes	Set to continuous, single or hold. Sweep with internal, external, or manual trigger.
Display	
Display data	Display data, memory, data and memory, or data math
Trace math	Vector division or subtraction of current linear measurement values and memory data.
Scale	Autoscale, scale, reference level, reference position Autoscale: Automatically selects scale resolution and reference value to center the trace. Autoscale all scales and all visible traces.
Title	Add custom titles to the display.
Limit lines	Define test limit lines that appear on the display for go/no go testing. Lines may be any combination of horizontal, sloping lines, or discrete data points. Each trace can have its own upper and/or lower limit line.
Limit test	Pass/fail display, audible beep
User Calibration Types	
Frequency response	Simultaneous magnitude and phase correction of frequency response errors for either reflection or transmission measurements.
Enhanced response	Corrects for frequency response and source match for transmission measurements, and provides one-port calibration for reflection measurements.
1-port calibration	Corrects for directivity, frequency response, and source match errors.
2-port calibration	Compensates for directivity, source match, reflection frequency response, load match, and transmission frequency response (full two-port S-parameters). Unknown thru and QSOLT are both available.
Multipoint calibration	Compensates for directivity, source match, reflection frequency response, load match, and transmission frequency response (full N-port S-parameters). Unknown thru and QSOLT are both available.
Guided calibration wizard	A calibration wizard is available that recommends a calibration type and calibration kit based on selected parameters and connector types. Alternatively, users can select their own calibration type and calibration kit.
Interpolated error correction	With any type of accuracy enhancement applied, interpolated mode recalculates the error coefficients when the test frequencies are changed. The number of points can be increased or decreased and the start/stop frequencies can be changed, but the resulting frequency span must be a subset of the original calibration frequency span.
Calibration kits	Supports all calibration kits supported by the PNA, including user defined calibration standards.
Calibration save/recall	Enables saving or recalling user calibration
Calibration display	The results of the calibration standard are displayed during the measurement.

Table 33. Software

Keysight IO library	<p>The IO library suite offers a single entry point for connection to the most common instruments including AXIe, PXI, GPIB, USB, Ethernet/LAN, RS-232, and VXI test instrument from Keysight and other vendors. It automatically discovers interfaces, chassis, and instruments. The graphical user interface allows you to search for, verify, and update IVI instrument and soft front panel drivers for modular and traditional instruments. The IO suite safely installs in side-by-side mode with NI I/O software.</p> <p>Free software download at www.keysight.com/find/iosuite</p>
Keysight soft front panel	<p>The PXI module includes a soft front panel (SFP), a software based graphical user interface (GUI) which enables the instrument's capabilities from your PC.</p> <p>Included on CD-ROM shipped with module or online</p>
Command Expert	<p>Assists in finding the right instrument commands and setting correct parameters. A simple interface includes documentation, examples, syntax checking, command execution, and debug tools to build sequences for integration in Excel, MATLAB, LabVIEW, VEE, and System VUE.</p> <p>Free software download at www.keysight.com/find/commandexpert</p>
Example programs	<p>Setting up a measurement</p> <p>Guided calibration</p> <p>Data acquisition</p> <p>Data transfer</p> <p>Included on CD-ROM shipped with module, or online at www.keysight.com/find/pxivna</p>
Example programming languages	<p>C, C++, C#, VB, LabVIEW</p>



www.keysight.com/find/myKeysight

A personalized view into the information most relevant to you.

www.axistandard.org

AdvancedTCA© Extensions for Instrumentation and Test (AXIe) is an open standard that extends the AdvancedTCA for general purpose and semiconductor test. Keysight is a founding member of the AXIe consortium.



www.lxistandard.org

LAN eXtensions for Instruments puts the power of Ethernet and the Web inside your test systems. Keysight is a founding member of the LXI consortium.



www.pxisa.org

PCI eXtensions for Instrumentation (PXI) modular instrumentation delivers a rugged, PC-based high-performance measurement and automation system.



Three-Year Warranty

www.keysight.com/find/ThreeYearWarranty

Keysight's combination of product reliability and three-year warranty coverage is another way we help you achieve your business goals: increased confidence in uptime, reduced cost of ownership and greater convenience.



Keysight Assurance Plans

Keysight Advantage Services

www.keysight.com/find/AssurancePlans

Five years of protection and no budgetary surprises to ensure your instruments are operating to specifications and you can continually rely on accurate measurements



www.keysight.com/go/quality

Keysight Electronic Measurement Group
DEKRA Certified ISO 9001:2008
Quality Management System

Keysight Channel Partners

www.keysight.com/find/channelpartners

Get the best of both worlds: Keysight's measurement expertise and product breadth, combined with channel partner convenience.

For more information on Keysight Technologies' products, applications or services, please contact your local Keysight office. The complete list is available at:

www.keysight.com/find/contactus

Americas

Canada	(877) 894-4414
Brazil	(11) 4197 3500
Mexico	01800 5064 800
United States	(800) 829-4444

Asia Pacific

Australia	1 800 629 485
China	800 810 0189
Hong Kong	800 938 693
India	1 800 112 929
Japan	0120 (421) 345
Korea	080 769 0800
Malaysia	1 800 888 848
Singapore	1 800 375 8100
Taiwan	0800 047 866
Other AP Countries	(65) 375 8100

Europe & Middle East

Belgium	32 (0) 2 404 93 40
Denmark	45 70 13 15 15
Finland	358 (0) 10 855 2100
France	0825 010 700* *0.125 €/minute
Germany	49 (0) 7031 464 6333
Ireland	1890 924 204
Israel	972-3-9288-504/544
Italy	39 02 92 60 8 484
Netherlands	31 (0) 20 547 2111
Spain	34 (91) 631 3300
Sweden	0200-88 22 55
United Kingdom	44 (0) 118 9276201

For other unlisted countries:

www.keysight.com/find/contactus



This information is subject to change without notice.

© Keysight Technologies 2014

Print Date: Sept 23, 2014

Supersedes: Sept 16, 2014

M9370-90002

www.keysight.com