

PG7000™ Series

Piston Gauges

Reference level pressure standards

Technical Data



The piston gauge's fundamental operating principle and excellent long term stability have made it an indispensable tool in high accuracy pressure metrology. As accuracy levels increase, quality assurance requirements intensify and automation spreads through the workplace, the piston gauge must evolve to continue to fill its essential role in the measurement system. PG7000, the first truly new, high end piston gauge introduced since the late 1970s, responds to this challenge.

PG7000 development was undertaken with four main inter-related design objectives:

- Deliver real improvements in fundamental metrological performance to assure that today's—and tomorrow's—ever increasing accuracy requirements can be supported.
- Integrate automated monitoring of environmental and instrument operating conditions

with extensive on-board intelligence to provide a modern stand alone instrument that outputs fully validated reference pressures, real time, through an intuitive operator interface.

- Reduce—and when possible eliminate—the influence of the operator on measurements to assure more consistent performance.
- Improve piston gauge ergonomics for greater operator satisfaction and increased productivity.

The PG7000 design objectives were pursued with the refinement of existing techniques, innovative new design, process improvements and the thorough application of today's digital and information processing technologies. The result is a coherent line of piston gauges that sets a new standard for both performance and usability, redefining the state of the art in high end pressure metrology.

General features

Integrated piston-cylinder metrological modules

Each PG7000 piston-cylinder is an integrated metrological assembly that includes the critical piston-cylinder mounting components. To change piston-cylinders, the complete module is installed and removed from the piston gauge mounting post. All of the mechanical parts that affect piston-cylinder metrology are associated with the individual piston-cylinder rather than being common parts of the piston gauge platform. This unique design provides many practical and metrological benefits.



Benefits

- Change ranges (piston-cylinders) in seconds, without using tools.
- Handle and interchange piston-cylinders without exposing critical surfaces to contamination.
- Protect the piston-cylinder from damage due to accidental shock or impact when handling.
- Improve measurement reproducibility by avoiding frequent assembly/disassembly of mounting components and assuring that each piston-cylinder is always used with the same mounting hardware, even when used in a different platform.
- Improve piston-cylinder mounting design by allowing each mounting system to be optimized for a piston-cylinder size and range rather than accepting the compromises of a single, interchangeable mounting system.

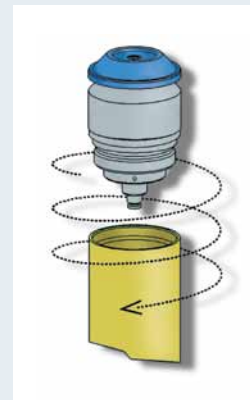

Installing a piston-cylinder module

Mass loading concentricity

Piston gauge performance is greatly affected by piston-cylinder verticality and mass loading concentricity. For optimum performance, the piston-cylinder axis must be aligned as well as possible with the acceleration due to gravity and the mass load must be concentric with the piston-cylinder axis.

Assuring piston-cylinder verticality and mass loading quality were key PG7000 design objectives. Piston-cylinder module alignment is established by the large diameter mating surface between the mounting post and the piston-cylinder module. The number of independent parts between the piston and mass load has been reduced to two (the piston cap and the mass loading bell). The piston head is effectively made part of the piston by machining it after installation concentric to the piston within ± 20 microns. PG7000 piston-cylinders have excellent mechanical characteristics but realizing their exceptional sensitivity and rotation times would not be possible without the special attention paid to alignment and mass loading quality.

Mass concentricity

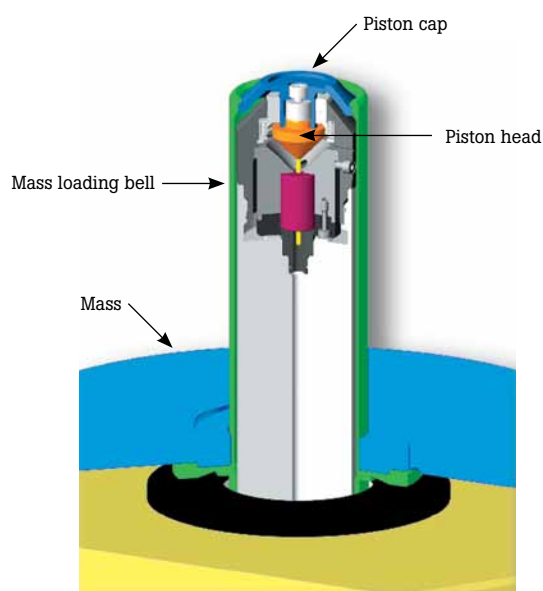

Integrated electronics, software and remote interfacing

PG7000 is a modern, digital instrument taking full advantage of today's sensor and data processing technologies supported by embedded software, an integrated local user interface and standard remote interfaces. Full feature operation is provided directly by the instrument itself without retrofits, add-on modules or external computers and software.

The electronics necessary for monitoring all ambient and instrument conditions and functions are integrated into the PG7000 platform. The display and keypad for the local operator are located on a compact terminal with the look and feel of other DHI products. The system power supplies are also contained in the terminal to remove their heat source from the PG platform.

Embedded software supports extensive on-board functions: displaying individual ambient condition variables and PG operating parameters—storing and recalling piston-cylinder and mass set metrological data—calculating fully compensated pressure to mass and mass to pressure values including all influences and head corrections—providing an objective, performance based go/no go indication of conditions for valid measurement.

PG platform



Rear connections

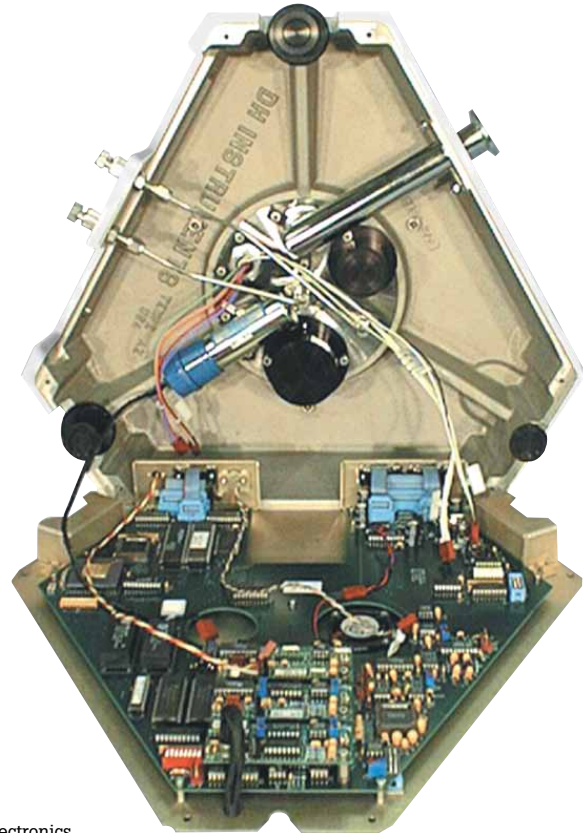

Electronics

PG terminal



Cover panel



Electronics

Local operator interaction with the PG7000, as with other modern test instruments, is through an integrated keypad and alphanumeric display not requiring an external computer or software. The keypad is function driven allowing rapid, intuitive operation. In addition, both RS-232 and IEEE 488 interfaces with extensive, fully documented, ASCII string commands are included for remote communication.

On-board measurement of operating conditions

PG7000 includes integrated on-board measurement of all the ambient and operating conditions needed to calculate pressure within tolerance. These include:

- Relative humidity: capacitance sensor on PG platform rear panel.
- Barometric pressure: internal piezoresistive sensor or by remote interfacing with any RS-232 barometer.
- Ambient temperature: platinum resistance thermometer mounted on PG platform rear panel.
- Piston-cylinder temperature: platinum resistance thermometer embedded in piston-cylinder mounting post.
- Reference vacuum (PG7601 only): piranni gauge integrated directly under bell jar vacuum plate.

The individual measurements can be observed real time, both locally through the PG Terminal and remotely over the RS-232 or IEEE 488 interface.

Provision for verification and recalibration of the on-board sensors is included and supported by PG7000's embedded software.

Monitoring piston behavior

Precise information on piston behavior is indispensable to achieving best performance with a high accuracy piston gauge. Piston position and fall rate are important to assure the piston is at the proper point in its stroke and falling at its natural rate. Piston rotation rate monitoring, though frequently ignored, is also very important to assure consistent operating conditions and detect possible piston-cylinder contamination.

PG7000 measures and provides real time indication of:

- Piston position
- Piston drop rate
- Piston rotation rate
- Piston rotation deceleration

Piston position is measured on the LVDT principle with a ring on the inside of the mass loading bell acting as the armature. Rotation rate is measured optically using a sensor in the mounting post which detects the movement of a notched ring on the inside of the mass loading bell. Both measurement systems are completely non-interfering. They have no influence on the free movement of the piston in any axis.

PG terminal display of ambient conditions

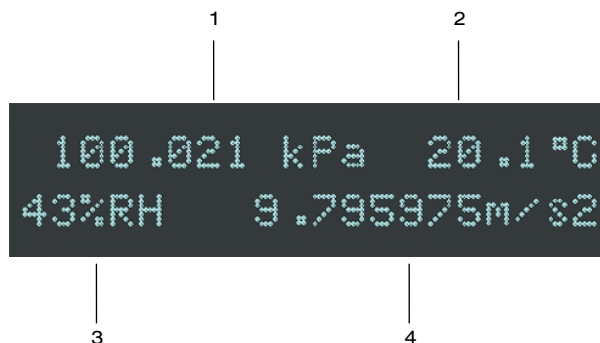

1. Barometric pressure
2. Ambient temperature
3. Ambient relative humidity
4. Local gravity

PG terminal display of piston behavior

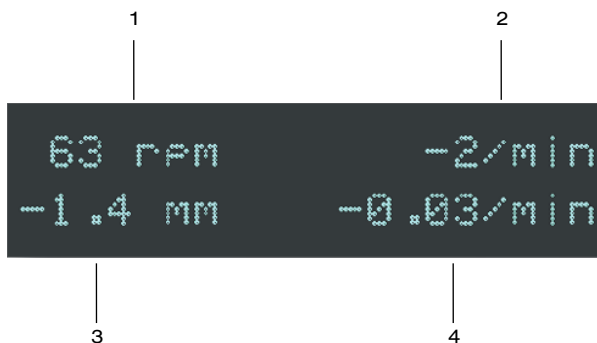

1. Rotation rate
2. Rotation deceleration
3. Position
4. Drop rate

Ready/not ready indication

PG7000 simplifies operation with a “ready/not ready” indication to provide the operator with a clear “go/no go” indication of when an in-tolerance measurement can be made.

The ready/not ready indication is based on testing for a variety of operating conditions including piston position, piston fall rate, piston rotation rate, piston rotation deceleration, piston temperature rate of change and vacuum reference (when applicable). A “ready” condition is indicated when all conditions fall within specific limits. If any condition is outside of limits, not ready is indicated with the responsible condition identified. The limits for the various “ready/not ready” criteria can be customized by the user if desired.

The “ready/not ready” feature assures that measurements are made under consistent conditions without requiring the operator to monitor multiple variables independently and/or make subjective judgements and decisions.

Piston near-float detection

Traditionally, one of the most tedious aspects of operating a piston gauge is adjusting pressure to float the piston. The procedure is delicate because the piston will lift, suddenly and without warning, only at the exact pressure corresponding to the mass loaded on the piston. Finding that point without overshooting requires slow and very cautious pressure control.

PG7000 makes it easier to float the piston (whether controlling pressure manually or automatically) with a piston preloading system that provides advance warning that the pressure is near the point where the piston will leave end of stroke. The preload is applied by spring loaded end of stroke stops. The spring force is equivalent to about a 2 kg (4.4 lb) load on the piston. The preload causes the piston to begin moving away from end of stroke before the pressure under the piston is equivalent to the mass loaded on the piston. The early movement of the piston is detected by PG7000 and visual and audible warnings that the piston is about to leave end of stroke are provided. The preloading system only affects the piston when it is at end of stroke, it does not interfere with the free movement of the piston when it is floating.

The piston preload system provides advance warning of piston float making it easier to operate a PG7000. The spring loaded stops also provide cushioning to dampen the impact when the piston reaches end of stroke to reduce wear and tear on the instrument.

PG terminal main run screen

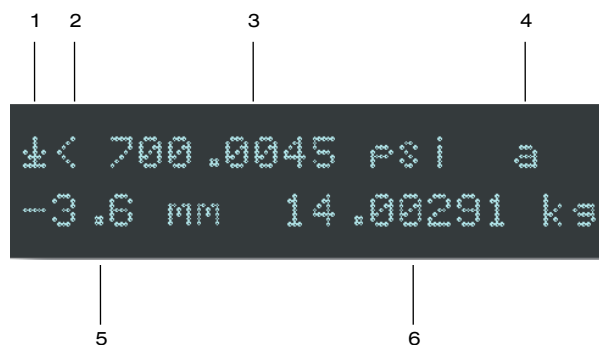

1. Piston too low (not ready)
2. Rotation rate too low (not ready)
3. Current defined pressure
4. Absolute mode
5. Piston position
6. Current mass loaded

Spring loading system detail

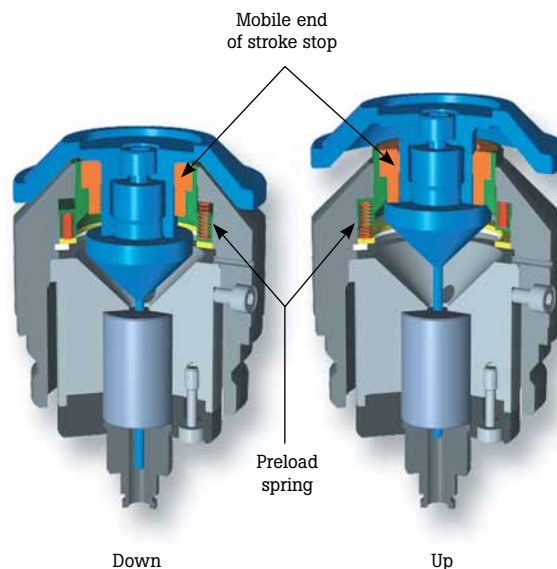

Intelligent piston rotation

In high performance piston-cylinders, the piston must be rotated to operate properly.

The rotation sets up centering forces that keep the piston aligned in the cylinder assuring a uniform annular gap and the piston's freedom and mobility. For the most repeatable pressure measurements, it is important that the rotation rate be consistent. In addition, when measurements are made, no drive system can be engaged as it would contribute parasitic forces and unquantifiable errors.

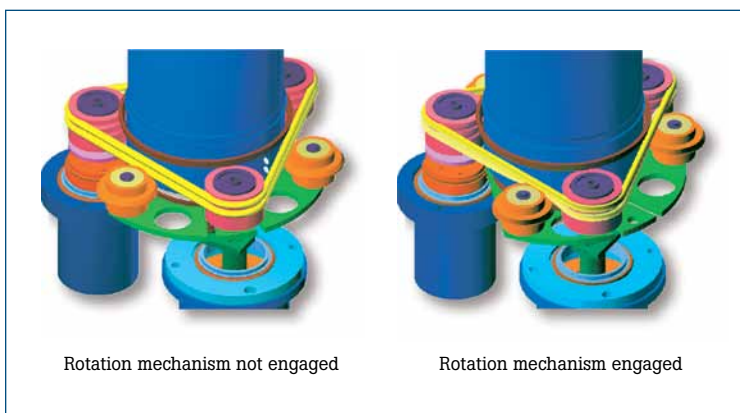

Rotation mechanism not engaged

Rotation mechanism engaged

PG7000 is the first commercially available piston gauge to provide monitoring of rotation rate and decay in rotation rate. These measurements, coupled with PG7000's internal logic, are used to assure that pressure readings are always made within rotation rate and decay in rotation rate limits. This relieves the operator of rotation rate monitoring responsibility and replaces subjective operator judgement with objective measurement.

In PG7000 platforms, the rotation stimulus may be provided either manually or by an optional motor drive. In most cases, manual rotation is adequate as PG7000 piston-cylinders require only occasional rotational acceleration and the rate of rotation monitoring system assures that measurements will be made within proper limits.

Motor driven rotation, when needed, is provided by a patented system that engages and disengages intelligently, depending on current rate of rotation, to maintain the rotation rate within limits. Unlike conventional piston drive systems, drive contact never occurs randomly

Storage and shipping containers

An important, but often overlooked, aspect of a high performance piston gauge package is its storage and shipping. Certain elements may only be used occasionally and recertification, particularly of the piston-cylinders and masses, is likely to require regular shipping off-site. In many cases, in-house shipping facilities are not aware of the need for special treatment of metrological items and are not properly equipped to package them adequately.

For PG7000 piston gauges the storing and shipping aspect has been carefully considered and addressed. The packaging provided for the piston gauge platform and mass set are heavy duty, weather proof, molded transit cases with custom inserts. These cases provide optimum protection and can be reused many times. PG7000 piston-cylinders modules are delivered in compact PVC bullet cases that are virtually indestructible. They provide a convenient short term storage vehicle ensuring the module is always protected when not mounted in the piston gauge. The bullet cases also provide excellent shipping protection.



Complete PG7000 system in shipping cases

or without warning. The rotation system can engage with the piston in any position and does not significantly affect its position or the set pressure. A warning is provided when the rotation system is about to engage and while it is running. An override is available so that engagement will occur only on operator demand.

Advanced pressure generation and control components

In day to day operation, the operator's main interaction with a piston gauge based pressure calibration system is with the pressure generation and control components. These are used constantly, both for the large pressure changes between increments and to perform the fine adjustments needed to float and refloat the piston. Over the years, the ease of use and reliability of these components will weigh heavily in the system's value as a calibration tool.

The central role of pressure generation and control components in meeting PG7000's objectives was recognized at the start of the PG7000 development process and stayed at the forefront. All PG7000 pressure accessories were designed specifically for their application, searching out ways to increase the efficiency and ergonomics of piston gauge operation.

PG7000 introduced fully automated gas pressure control in a bench top piston gauge system which, coupled with PG7000's other intelligent features, leaves only loading and unloading masses in response to system prompts to the operator.

A manual gas pressure controller is also available. It is compact in size to facilitate system setup and features custom, soft grip valve knobs—not just a detail if you are the one using them day in and day out.

OPG1, the hydraulic pressure generator/controller for PG7302, breaks new ground in oil piston gauge operation. With a perfect balance between the benefits of automation and the practicality of direct operator control, it sets pressures effortlessly, precisely and very quickly, eliminating the pumping and screw press cranking for which oil piston gauges were once notorious.

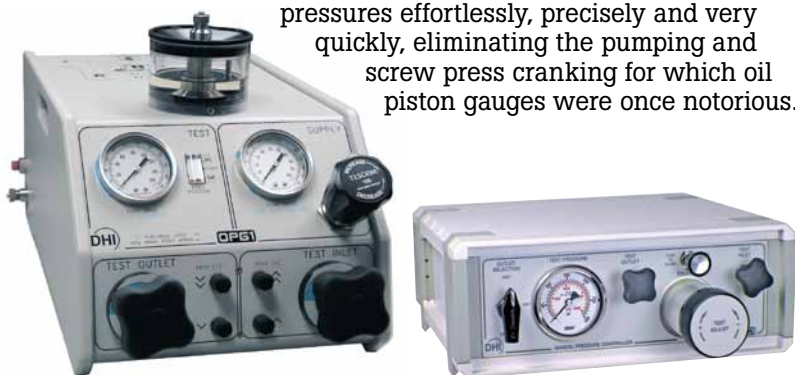

OPG1 Hydraulic Pressure Generator/Controller MPC1 Manual Pressure Controller

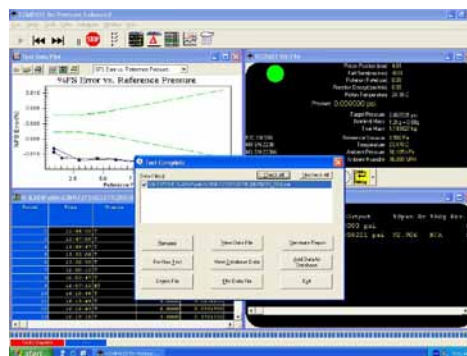

COMPASS® for pressure main run screen

COMPASS® for Pressure calibration assistance software

COMPASS for Pressure calibration assistance software takes PG7000 to the next step in automating calibrations.

Since PG7000 on-board electronics and software handle all the basic metrological and system monitoring aspects of PG7000 operation, COMPASS is not required to operate the system and make accurate measurements. COMPASS concentrates on optimizing the broader application of PG7000 in a calibration laboratory. COMPASS sets up device under test (DUT) records, defines and associates test procedures with DUTs, runs tests, acquires reference and test data, produces standard and custom calibration reports. All instrument, DUT and test data is collected and stored in standard delimited files that can be easily downloaded to other applications.

A unified solution from vacuum to 500 MPa

From its inception, the PG7000 line of piston gauges was designed to cover the complete range of pressure from very low absolute and differential in gas, up to 500 MPa (75 000 psi) in oil. While several piston gauge platforms and specialized accessories, may be needed to cover different ranges and media, a consistent user interface and operational principles are maintained throughout the line. In most cases, complete gas and oil calibration capability can be achieved with just two PG platforms, four piston-cylinder modules and one mass set. This provides consistency from system to system which facilitates operation and training. Operators do not need to learn and operate several completely different systems to cover the full pressure range. Maintenance costs are reduced by minimizing the number of metrological elements to be supported.

PG7302™ Platform

Oil pressures from 100 kPa to 500 MPa (14.5 to 75 000 psi)



OPG1

PG7302™

PG7302 is recommended for covering gauge and absolute pressure with oil as the pressurized medium. Absolute mode is supported by automated measurement and addition of atmospheric pressure using PG7302's internal barometer or any external barometer supporting RS232 communications. To cover gas pressures under 11 MPa (1 600 psi), see PG7102 and PG7601. For information on covering gas pressures greater than 11 MPa (1 600 psi), please contact DHI.

Features

Includes all PG7000 standard features and the following:

- Special provisions for oil operation including a spent oil run off tray and a purging system to remove air under the piston during piston-cylinder module installation
- Motorized piston rotation is optional (rotation rate monitoring and "ready/not ready" indication are always included)

Putting together a PG7302 system

A typical PG7302 calibration systems consists of:

- PG7302 Platform
- Piston-Cylinder Modules: see information on PG7302 piston-cylinders and the ranges that they provide when combined with PG7302 mass set choices
- Mass Set: 35, 40, 45, 55, 80 and 100 kg mass sets are available
- Pressure Generation/Control Component
Choices available for PG7302 include:
 - OPG1-30000 Hydraulic Pressure Generator/Controller: power assisted pressure generation and control to 200 MPa (30 000 psi) (see OPG1 brochure)
 - 5:1 Intensifier Option: extends OPG1-30000 pressure generation range to 500 MPa (75 000 psi)

Other optional accessories available

- RPM4-A0015 Reference Pressure Monitor
Interfaces directly with PG7302 to provide higher accuracy barometric pressure readings than the PG7302 on-board barometer (see RPM4 brochure). Recommended for operation in "absolute by addition of atmosphere" mode.
- COMPASS® for Pressure: Applications software for IBM compatible PC that interfaces with PG7302 to support DUT records, running tests, acquiring data, and maintaining calibration records and generating reports, as well as providing enhanced operational monitoring displays.

PG7102™ Platform

Gas pressures from 2 kPa to 11 MPa (0.2 to 1 600 psi)



MPC1



PG7102™

PG7102 is recommended for covering gauge and absolute pressures above atmosphere with gas as the pressurized medium. Absolute mode is supported by automated measurement and addition of atmospheric pressure using PG7102's internal barometer or any external barometer supporting RS-232 communications. PG7102 does not cover absolute or gauge pressures below atmospheric pressure. To cover absolute and gauge pressures near and under atmosphere and/or for best accuracy on absolute pressures under about 1 500 kPa (200 psi), use PG7601. For information on covering gas pressures greater than 11 MPa (1 600 psi), please contact DHL.

Putting together a PG7102 system

A typical PG7102 calibration systems consists of:

- PG7102 Platform
- Piston-Cylinder Modules: see information on PG7102 piston-cylinders and the ranges that they provide when combined with PG7102 mass set choices
- Mass Set: 35, 40, 45 and 55 kg mass sets are available
- Pressure Generation/Control Component
Choices available for PG7102 include:
 - MPC1-1000: manual pressure control up to 7 MPa (1 000 psi) (see MPC1 brochure)
 - MPC1-3000: manual pressure control up to 20 MPa (3 000 psi) (see MPC1 brochure)
 - PPC3-7Mu: automated pressure control up to 7 MPa (1 000 psi) (see PPC3 brochure)

Features

Includes all PG7000 standard features and the following:

- Lower cost, simplified gas operated platform does not include vacuum reference capability.
- Motorized piston rotation is optional (rotation rate monitoring and ready/not ready indication are always included).

- Interconnections Kit: to connect the PG7102 to the pressure generation/control component and provide a quick-connector test connection. P/N 400985, PK-7000-PPC/MPC, Interconnections kit.

Other optional accessories available:

- RPM4-A0015 Reference Pressure Monitor: interfaces directly with PG7102 to provide higher accuracy barometric pressure readings than the PG7102 on-board barometer (see RPM4 brochure). Recommended for operation in "absolute by addition of atmosphere" mode.
- COMPASS® for Pressure: applications software for IBM compatible PC that interfaces with PG7102 to support DUT records, running tests, acquiring data, maintaining calibration records and generating reports as well as providing enhanced operational monitoring displays.

PG7601™ Platform

Gas pressures with vacuum reference
from 5 kPa to 7 MPa (0.7 to 1 000 psi)



PG7601™

PPC3

PG7601 is recommended for covering absolute and gauge pressures with gas including pressures near and under atmospheric pressure. PG7601 measurements can be referenced to vacuum by evacuating the bell jar that covers the mass load. If absolute and gauge pressures near and under atmosphere are not required and/or pressure greater than 7 MPa (1 000 psi) is required, PG7102, which does not include vacuum reference capability, should be considered.

Features

Includes all PG7000 standard features and the following:

- Supports establishing and measuring a vacuum reference for defining absolute pressures relative to an evacuated bell jar. Includes bell jar and integrated vacuum gauge.
- Supports “differential mode” operation to cover positive and negative differential pressures near zero and at different static pressures (see Technical Note 9940TN02).

Putting together a PG7601 System

A typical PG7601 calibration systems consists of:

- PG7601 Platform
- Piston-Cylinder Modules: See information on PG7601 piston-cylinders and the ranges they provide when combined with the PG7601 mass set.
- 35 kg Mass Set
- Pressure Generation/Control Component
Choices available for PG7601 include:
 - MPC1-1000: manual pressure control up to 7 MPa (1 000 psi) (see MPC1 brochure)
 - PPC3-7Mu: automated pressure control up to 7 MPa (1 000 psi) (see PPC3 brochure)
- Interconnections Kit
Choices available for PG7601 include:
 - To connect PG7601 to the pressure generation/control component and provide a quick-connector test connection P/N 400985, PK-7000-PPC/MPC, interconnections kit
 - To connect PG7601 to the pressure generation/control component and provide test connections and valving for differential mode operation, P/N 401581, PK-7600-PPC/MPC-DIF

Vacuum pumps and accessories

- Vacuum pump and accessories to establish vacuum under the PG7601 bell jar, P/N 401209, VA-7601-REF (110V) or P/N 401453 (220 V).
- Vacuum pump and accessories to set pressure under atmosphere using PPC3 or MPC1, VA-PPC/MPC-REF, P/N 400922 (110 V) or P/N 401160 (220 V).

Other optional accessories available

- RPM4-A0015 Reference Pressure Monitor: interfaces directly with PG7601 to provide higher accuracy barometric pressure readings than the PG7601 on-board barometer (see RPM4 brochure). Required for “differential mode” operation.
- COMPASS® for Pressure: applications software for IBM compatible PC that interfaces with PG7601 to support DUT records, running tests, acquiring data, maintaining and generating calibration records as well as providing enhanced operational monitoring displays.

PG7000™ Piston-Cylinder Modules

The piston-cylinder defines effective area and is the piston gauge's principal metrological element. The piston-cylinder's intrinsic characteristics and how it is mounted and exploited are the keys to piston gauge performance.

PG7000 piston-cylinders are manufactured by DHI using proprietary production techniques developed specifically for the PG7000 series. These result in pistons and cylinders whose typical shape is within less than 0.2 micron from ideal geometry. Gas operated piston-cylinders use large diameters and very small annular gaps to minimize gas species and operating mode effects and to maximize piston float times. For example, the typical annular gap of a 35 mm gas operated piston-cylinder is less than 1 micron. Oil operated piston-cylinders use small diameters to reduce the quantity of mass needed to cover the typical high pressure range.

All Type 7000 pistons and cylinders are made of tungsten carbide except the standard 35 mm gas operated piston which is made of high purity ceramic to reduce its mass and thus its minimum starting pressure. Each PG7000 piston-cylinder is a complete, integrated metrological assembly that includes the critical piston-cylinder mounting components. This approach improves metrological performance as well as offering many practical advantages.

All Type 7000 piston-cylinders use free deformation mounting systems in which the cylinder is allowed to deform under the influence of applied pressure without O-rings or seals along the cylinder length. For the higher pressure gas assemblies, a new mounting system designated negative free deformation has been developed. Negative free deformation applies the measured pressure uniformly along the full length of the cylinder. This reduces deformation under pressure so that piston drop rates remain low, even at high operating pressures while avoiding the unpredictable strain points of conventional reentrant designs.

Piston cylinder and module



Piston-cylinder



Piston-cylinder module

Piston cylinder and module

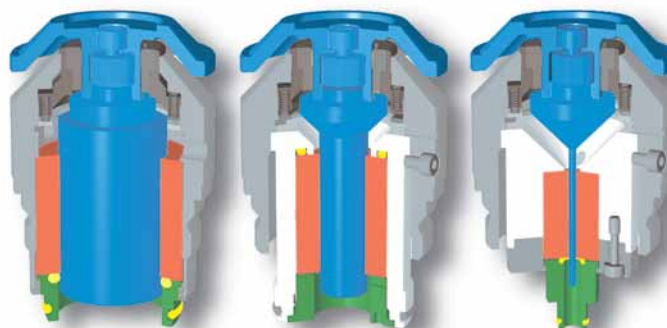

Simple free deformation, gas

Negative free deformation, gas

Simple free deformation, oil

PG7000™ Mass Sets

Masses are loaded on the piston and accelerated by gravity to apply a known force on the piston against which the defined pressure is balanced.

A complete PG7000 mass set includes main masses of 10 kg (22 lb) or 5 kg (11 lb) each, fractionary masses in 5-2-2-1 progression from 0.5 kg (18 oz) to 0.1 kg (4 oz) and a trim mass set with masses from 50 g (1.8 oz) to 0.01 g (.0004 oz). The mass set composition is such that any desired mass value within the mass set range can be loaded within 0.01 g (.0004 oz). Different size mass sets and piston-cylinder choices provide flexibility in putting together a PG7000 system whose ranges best fit your needs.

All main masses are machined from solid, non-magnetic stainless steel and adjusted to their nominal values in the mass without cavities or trimming hardware which can reduce mass stability over time.

Since loading and unloading masses is one of the most common operator interactions with a PG7000 system, the individual masses and the mass set have been designed to maximize handling convenience. Ample angled lifting surfaces are provided on the edge of each mass and special mass trays are included to assist in orderly mass loading and unloading.

Standard PG7000 pistons are adjusted to a mass of 0.2 kg (7 oz). The first mass loaded on the piston is the mass loading bell onto which all the other masses are loaded. The mass loading bell is delivered with the PG platform. There are two different mass loading bells. The 7001 bell is a short bell that fits under the PG7601's bell jar. The 7002 bell is a longer bell used on all the other PG7000 models. The 7001 bell has a mass of 0.3 kg (10.6 oz); the 7002 bell has a mass of 0.8 kg (1.8 lb). Both bells are made of titanium to minimize their mass.



Mass set on mass tray

Mass concentricity



Mass transit cases



General specifications

General		
Power requirements	85 V to 264 V ac, 47 to 440 Hz, 22 VA max consumption	
Operating temperature range	15 °C to 35 °C (59 °F to 95 °F)	
Weight (Instrument platform with no mass loaded)	PG7102	13 kg (28 lb)
	PG7302	13 kg (28 lb)
	PG7601	17 kg (37 lb)
	PG terminal	1.4 kg (3 lb)
Dimensions (H x W x D)	Instrument platform	36 cm x 40 cm x 35 cm (14.5 in x 15.8 in x 13.8 in) (Height: Top of mounting post with piston-cylinder module installed for PG7102/PG7302; top of bell jar for PG7601)
	PG terminal	12 cm x 15 cm x 20 cm (4.7 in x 5.9 in x 7.9 in)
Microprocessors	Instrument platform	Motorola 68302
	PG terminal	Hitachi 64180
Communications ports	RS-232	COM1: Host computer COM2: External barometer COM3: Automated pressure controller
	IEEE-488.2	Host computer
Maximum pressure ranges	Actual range depends on piston-cylinder and mass set selection.	
	PG7102	Gauge: 10 kPa to 11 MPa (1.5 psi to 1 600 psi) Absolute: 110 kPa to 11 MPa (16 psi to 1 600 psi)
	PG7302	Gauge: 100 kPa to 500 MPa (15 psi to 75 000 psi) Absolute: 200 kPa to 500 MPa (30 psi to 75 000 psi)
	PG7601	Gauge: 5 kPa to 7 MPa (0.7 psi to 1 000 psi) Absolute: 5 kPa to 7 MPa (0.7 psi to 1 000 psi) Differential: -90 to 350 kPa (16 psi to 1 600 psi) at line pressure of 15 to 200 kPa absolute (2.2 psi to 30 psi)
Operating media	PG7102	Gas: air, helium, nitrogen
	PG7302	Oil: Di2-Ethyl Hexyl Sebacate (oil)
	PG7601	Gas: air, helium, nitrogen
Maximum mass load	PG7102	55 kg (121 lb)
	PG7302	100 kg (220 lb)
	PG7601	35 kg (77 lb)
Pressure connections	Test port	PG7102: DH200
		PG7302: DH500
		PG7601: DH200
	Note: DH200 and DH500 are gland and collar type fittings for 6 mm (.25 in) coned and left hand threaded tube. DH200 is equivalent to AE SF250C, HIP LF4, etc. DH500 is equivalent to AE F250C, HIP HF4, etc.	
PG7601 Only	Bell jar vent port: DH200 Vacuum pump down port: KF25	
CE conformance	Available, must be specified	
Ambient and instrument condition measurement		
Temperature (ambient)	Range: 0 °C to 40 °C (32 °F to 104 °F) Resolution: 0.1 Accuracy: ± 1	
Temperature (piston-cylinder module)	Range: 0 °C to 40 °C (32 °F to 104 °F) Resolution: 0.01 Accuracy: ± 0.1	
Barometric pressure with internal sensor	Range: 70 to 110 kPa Resolution: 10 Pa Accuracy: ± 140 Pa Barometric pressure can also be read automatically from any RS-232 device such as DHI RPM4.	
Relative humidity	Range: 5 to 95 %RH Resolution: 1 %RH Accuracy: ± 10 %RH	
Piston position	Range: ± 4.5 mm Resolution: 0.1 mm Accuracy: ± 0.2	
Piston rotation (rate and deceleration)	Range: 2 to 150 rpm Resolution: 1 rpm	
Vacuum (PG7601 only)	Range: 0 to 20 Pa Resolution: 0.01 Pa Accuracy: ± 0.1 Pa or 10% of reading, whichever is greater	

Embedded features

- Local control with 2 x 20 electroluminescent and 4 x 4 function driven keypad.
- Real time (1 second update rate) display and measurement of ambient (pressure, temperature, humidity) and instrument (piston-cylinder temperature, piston position, piston drop rate, piston rotation rate, piston rotation decay rate) conditions.
- Real time (1 second update rate) mass to pressure and pressure to mass calculations taking into consideration all environmental and operational variables.
- Gas and liquid head corrections.
- Adjustable mass loading resolution (0.1 kg to 0.01 g).
- Audible prompts of instrument status with override capability.
- Interfacing and automatic exploitation of any external barometer (RS-232).
- Storage and one step activation of metrological data on up to 18 piston-cylinder modules and 3 mass sets.
- Continuous pressure ready/not ready indication based on measured conditions for valid measurement.
- Intelligent piston drive system based on measured rotation rate with operator alert and manual override (optional on PG7102, PG7302).
- Built-in drivers for automated pressure control components with override capability.
- Full RS-232 and IEEE-488.2 communications with multi-level commands to set and read all instrument functions.

Piston-cylinder module specifications

General		
All piston-cylinders are integrated modules including mounting hardware delivered in individual shipping and storage bullet cases.		
Cylinder material	Tungsten carbide	
Piston material	Tungsten carbide	
Mounting system	PC-7200-x	Negative free deformation
	PC-7100/7600-50, -100, -200	Negative free deformation
	All Others	Simple free deformation

Pressure measurement: PG7102/7601					
	PG-7100/7600-10-L and -10, TC	PC-7100/7600-20	PC-7100/7600-50	PC-7100/7600-100	PC-7100/7600-200
Sensitivity ¹	0.02 Pa + 0.5 ppm	0.04 Pa + 0.5 ppm	0.1 Pa + 0.5 ppm	0.2 Pa + 0.5 ppm	0.4 Pa + 0.5 ppm
Reproducibility ²	± 2 ppm	± 2 ppm	± 2 ppm	± 3 ppm	± 3 ppm
Uncertainty ³	± (0.2 Pa + 12 ppm)	± (0.2 Pa + 14 ppm)	± (0.5 Pa + 14 ppm)	± (1 Pa + 20 ppm)	± (2 Pa + 20 ppm)
Typical drop rate ⁴		0.3 mm/min @ 700 kPa	0.5 mm/min @ 1750 kPa	0.7 mm/min @ 3500 kPa	1.0 mm/min @ 7000 kPa
Typical Drop Rate -10, TC ⁴	0.2 mm/min @ 350 kPa				
Typical drop rate 10-L ⁴	0.15 mm/min @ 350 kPa				

Pressure measurement: PG7202 ⁵					
	PC-7202-100	PC-7202-200	PC-7202-500	PC-7202-1	PC-7202-2
Sensitivity ¹	2 Pa + 1 ppm	4 Pa + 1 ppm	10 Pa + 1 ppm	20 Pa + 1 ppm	40 Pa + 1 ppm
Reproducibility ²	± 2 ppm	± 3 ppm	± 3 ppm	± 3 ppm	± 4 ppm
Uncertainty ³	± (2 Pa + 20 ppm)	± (3 Pa + 20 ppm)	± [7 Pa + (18 ppm +0.15 ppm/MPa)]	± [15 Pa + (20 ppm +0.15 ppm/MPa)]	± [30 Pa + (30 ppm +0.15 ppm/MPa)]
Typical drop rate ⁴	0.10 mm/min @ 5 MPa	0.15 mm/min @ 10 MPa	0.20 mm/min @ 25 MPa	0.25 mm/min @ 50 MPa	0.50 mm/min @ 100 MPa

Pressure measurement: PG7302						
	PC-7300-100	PC-7300-200	PC-7300-500	PC-7300-1	PC-7300-2	PC-7300-5
Sensitivity ¹	2 Pa + 1 ppm	4 Pa + 1 ppm	10 Pa + 1 ppm	20 Pa + 1 ppm	40 Pa + 1 ppm	100 Pa + 1 ppm
Reproducibility ²	± 2 ppm	± 3 ppm	± 3 ppm	± 3 ppm	± 4 ppm	± 6 ppm
Uncertainty ³	± (16 Pa + 18 ppm)	± (16 Pa + 20 ppm)	± (20 Pa + 20 ppm)	± (25 Pa + 25 ppm)	± [40 Pa + (25 ppm +0.04 ppm/MPa)]	± [100 Pa + (35 ppm + 0.04 ppm/MPa)]
Typical drop rate ⁴	0.02 mm/min @ 5 MPa	0.04 mm/min @ 10 MPa	0.10 mm/min @ 25 MPa	0.2 mm/min @ 50 MPa	0.40 mm/min @ 100 MPa	1.0 mm/min @ 250 MPa

¹ Sensitivity: the smallest variation in input detectable in output. Sensitivity is given as a full uncertainty (2a) at k=2. k=1 value is obtained by dividing each part by the square root of 12.

² Reproducibility: combined long term stability of piston-cylinder effective area and masses.

³ Typical pressure Measurement Uncertainty: All relevant sources of uncertainty under typical operating conditions are identified, quantified and combined following the "Guide to the Expression of Uncertainty in Measurement (GUM)". DHI Technical Note 7920TN01 (latest revision) documents the detailed uncertainty analysis for each platform, piston-cylinder and operating mode, and can be used to derive uncertainty in pressure in a user's specific conditions. Uncertainties are for manual mass loading. The use of AMH improves uncertainty for some ranges.

⁴ Typical drop rate: typical drop rate at the pressure given.

⁵ PG7202 is a PG7000 platform designed for high pressure gas measurement to 100 MPa. See PG7202 brochure.

Ranges and technical characteristics

Ranges for gas operated piston-cylinders for PG7102 and PG7601

Designator	Pressure to mass (/kg)	Minimum pressure						Maximum pressure							
		PG7102/7601 (piston only)		PG7102 (piston and bell)		PG7601 (piston and bell)		35 kg (77 lb)		40 kg (88 lb)		45 kg (99 lb)		55 kg (121 lb)	
		(kPa)	(psi)	(kPa)	(psi)	(kPa)	(psi)	(kPa)	(psi)	(kPa)	(psi)	(kPa)	(psi)	(kPa)	(psi)
PC-7100/7600-10-L	10 kPa	4	0.6	12	1.7	7	1	350	50	400	60	450	65	550	80
PC-7100/7600-10, TC	10 kPa	5	0.7	13	2.0	8	1.2	350	50	400	60	450	65	550	80
PC-7100/7600-20	20 kPa	4	0.6	20	3.0	10	1.4	700	100	800	120	900	130	1 100	160
PC-7100/7600-50	50 kPa	10	1.5	50	7.5	25	3.7	1 750	250	2 000	300	2 250	325	2 750	400
PC-7100/7600-100	100 kPa	20	2.9	100	14.5	50	7.25	3 500	500	4 000	600	4 500	650	5 550	800
PC-7100/7600-200	200 kPa	40	5.8	200	29.0	100	14.5	7 000	1 000	8 000	1 200	9 000	1 300	11 000	1 600

Optimal performance starts with the piston and mass bell loaded. PG7601 only accepts a 35 kg mass set (MS-7001-35).

Technical characteristics for gas operated piston-cylinders for PG7102 and PG7601

Designator	Nominal diameter	Nominal area	Piston assembly mass	Piston material	Cylinder material	Mounting system
PC-7100/7600-10-L	35 mm (1.3 in)	980 mm ² (1.5 in ²)	400 g (14 oz)	Tungsten carbide	Tungsten carbide	Simple free deformation
PC-7100/7600-10, TC	35 mm (1.3 in)	980 mm ² (1.5 in ²)	500 g (18 oz)	Tungsten carbide	Tungsten carbide	Simple free deformation
PC-7100/7600-20	25 mm (1 in)	500 mm ² (.8 in ²)	200 g (7 oz)	Tungsten carbide	Tungsten carbide	Simple free deformation
PC-7100/7600-50	16 mm (.6 in)	196 mm ² (.3 in ²)	200 g (7 oz)	Tungsten carbide	Tungsten carbide	Negative free deformation
PC-7100/7600-100	11 mm (.4 in)	100 mm ² (.2 in ²)	200 g (7 oz)	Tungsten carbide	Tungsten carbide	Negative free deformation
PC-7100/7600-200	8 mm (.3 in)	50 mm ² (.08 in ²)	200 g (7 oz)	Tungsten carbide	Tungsten carbide	Negative free deformation

Ranges for oil operated piston-cylinders for PG7302

Designator	Pressure to mass (/kg)	Minimum pressure				Maximum pressure (depending on mass set)											
		Piston only		Piston and bell		35 kg (77 lb)		40 kg (88 lb)		45 kg (99 lb)		55 kg (121 lb)		80 kg (176 lb)		100 kg (220 lb)	
		(kPa)	(psi)	(kPa)	(psi)	(kPa)	(psi)	(kPa)	(psi)	(kPa)	(psi)	(kPa)	(psi)	(kPa)	(psi)	(kPa)	(psi)
PC-7300-100	100 kPa	20	3	100	15	3.5	500	4	600	4.5	650	5	725	8	1 150	10	1 450
PC-7300-200	200 kPa	40	5	200	29	7	1 000	8	1 200	9	1 300	11	1 600	16	2 300	20	2 900
PC-7300-500	500 kPa	100	15	500	73	17.5	2 500	20	3 000	22.5	3 250	27.5	4 000	40	5 800	50	7 250
PC-7300-1	1 MPa	200	30	1 000	145	35	5 000	40	6 000	45	6 500	55	8 000	80	11 500	100	14 500
PC-7300-2	2 MPa	400	60	2 000	290	70	10 000	80	12 000	90	13 000	110	16 000	160	23 000	200	29 000
PC-7300-5	5 MPa	1 000	145	5 000	725	175	25 000	200	30 000	225	32 500	275	40 000	400	58 000	500	72 500

Optimal performance starts with the piston and mass bell loaded.

Technical characteristics for oil operated piston-cylinders for PG7302

Designator	Nominal diameter	Nominal area	Piston assembly mass	Piston material	Cylinder material	Mounting system
PC-7300-100	11.2 mm (.4 in)	98.5 mm ² (.15 in ²)	200 g (7 oz)	Tungsten carbide	Tungsten carbide	Simple free deformation
PC-7300-200	7.9 mm (.3 in)	49 mm ² (.08 in ²)	200 g (7 oz)	Tungsten carbide	Tungsten carbide	Simple free deformation
PC-7300-500	5 mm (.2 in)	19.6 mm ² (.03 in ²)	200 g (7 oz)	Tungsten carbide	Tungsten carbide	Simple free deformation
PC-7300-1	3.5 mm (.14 in)	9.8 mm ² (.02 in ²)	200 g (7 oz)	Tungsten carbide	Tungsten carbide	Negative free deformation
PC-7300-2	2.5 mm (.1 in)	4.9 mm ² (.008 in ²)	200 g (7 oz)	Tungsten carbide	Tungsten carbide	Negative free deformation
PC-7300-5	1.6 mm (.06 in)	1.9 mm ² (.003 in ²)	200 g (7 oz)	Tungsten carbide	Tungsten carbide	Negative free deformation

Mass set specifications

General specifications

Masses (All masses are delivered in molded, reusable transit cases with custom inserts)		
Masses > 50 g (1.8 oz)	Material	304L non-magnetic stainless steel
	Finish	Eletropolished
	Adjustment tolerance	± 20 ppm of nominal value
	Accuracy of measured values	± 5 ppm or 1 mg, whichever is greater
Masses < 50 g (1.8 oz)	Traceability of measured values	National Institute of Standards and Technology (NIST)
	Conform to NIST S1	

Mass set compatibility

Designator	Nominal total mass	PG7102	PG7302	PG7601
MS-7001-35	35 kg (77 lb)			•
MS-7002-35	35 kg (77 lb)	•	•	
MS-7002-40	40 kg (88 lb)	•	•	
MS-7002-45	45 kg (99 lb)	•	•	
MS-7002-55	55 kg (121 lb)	•	•	
MS-7002-80	80 kg (176 lb)		•	
MS-7002-100	100 kg (220 lb)		•	

PG7000 mass set definitions

Designator	Nominal total mass	Mass set composition									Piston ¹	Bell ¹
		10 kg (22 lb)	5 kg (11 lb)	2 kg (4.4 lb)	1 kg (2.2 lb)	0.5 kg (1 lb)	0.2 kg (.44 lb)	0.1 kg (.22 lb)	Trim set 50 g to 0.1 g (1.8 oz to .003 oz)	Make up mass ¹		
MS-7001-35	35 kg (77 lb)	–	5	2	1	1	2	1	1	1 [4.5 kg (10 lb)]	0.2 ² (7 oz)	0.3 kg (10.6 oz)
MS-7002-35	35 kg (77 lb)	–	5	2	1	1	2	1	1	1 [4 kg (9 lb)]	0.2 (7 oz)	0.8 kg (28 oz)
MS-7002-40	40 kg (88 lb)	–	6	2	1	1	2	1	1	1 [4 kg (9 lb)]	0.2 (7 oz)	0.8 kg (28 oz)
MS-7002-45	45 kg (99 lb)	–	7	2	1	1	2	1	1	1 [4 kg (9 lb)]	0.2 (7 oz)	0.8 kg (28 oz)
MS-7002-55	55 kg (121 lb)	–	9	2	1	1	2	1	1	1 [4 kg (9 lb)]	0.2 (7 oz)	0.8 kg (28 oz)
MS-7002-80	80 kg (176 lb)	6	1	2	1	1	2	1	1	1 [4 kg (9 lb)]	0.2 (7 oz)	0.8 kg (28 oz)
MS-7002-100	100 kg (220 lb)	8	1	2	1	1	2	1	1	1 [4 kg (9 lb)]	0.2 (7 oz)	0.8 kg (28 oz)

Note: The piston and the mass loading bell are not included in the mass set. Piston-cylinders are ordered separately and the mass loading bell is delivered with the PG7000 platform.

¹ The make up mass is the first main mass loaded on the piston and bell to reach an even increment of 5 kg (11 lb) or 10 kg (22 lb).

² PC-7100/7600-10, TC with a tungsten carbide piston has a piston mass of 0.5 kg (11 lb).

Individual masses



Ordering information

Platform

Model

PG7302 Oil operated piston gauge

PG7302 Oil operated piston gauge with motorized piston rotation

PG7302-CE Oil operated piston gauge, CE compliant

PG7302-CE Oil operated piston gauge, with motorized piston rotation, CE compliant

PG7102 Gas operated piston gauge

PG7102 Gas operated piston gauge, with motorized piston rotation

PG7102-CE Gas operated piston gauge, CE compliant

PG7102-CE Gas operated piston gauge with motorized piston rotation, CE compliant

PG7601 Gas operated piston gauge, with motorized piston rotation

PG7601-CE Gas operated piston gauge, with motorized piston rotation, CE compliant

Standard accessories

Mass loading bell

Reusable molded transit case with custom inserts

Power cord

Instrument dust cover

Technical data report

Adaptor for test connection (depends on model)

Dust cover

Wear subjected parts kit

Bell jar (PG7601 only)

KF 25 plug, O-ring assembly and clamp for reference vacuum connection (PG7601 only)

Calibration report*

Mass set

Model

MS-7001-35 35 kg mass set, w/4.5kg make up

MS-7002-35 35 kg mass set, w/4 kg make up

MS-7002-40 40 kg mass set, w/4 kg make up

MS-7002-45 45 kg mass set, w/4 kg make up

MS-7002-55 55 kg mass set, w/4 kg make up

MS-7002-80 80 kg mass set, w/9 kg make up

MS-7002-100 100 kg mass set, w/9 kg make up

Included

Shipping and storage cases (molded, reusable)

Mass trays

Dust cover

Calibration report*

Standard accessories

Reusable molded transit case with custom inserts

Mass presentation tray

Dust cover

Calibration report

* Reporting complete technical characteristics and true mass values traceable to the United States National Institute of Standards and Technology (NIST).

Piston-cylinder module

Model

PC-7100/7600-10-L Gas P-C module

PC-7100/7600-10, TC Gas P-C module

PC-7100/7600-50 Gas P-C module

PC-7100/7600-200 Gas P-C module

PC-7300-100 Oil P-C module

PC-7300-200 Oil P-C module

PC-7300-500 Oil P-C module

PC-7300-2 Oil P-C module

PC-7300-5 Oil P-C module

Included

PVC "Bullet" case

Calibration report (consult DHI about converting existing Type 5000 piston-cylinders for use in a Type 7000 piston gauge.)

Standard accessories

Bullet case

Calibration report*

Fluke Calibration.

Precision, performance, confidence.™

Fluke Calibration

PO Box 9090, Everett, WA 98206 U.S.A.

Fluke Europe B.V.

PO Box 1186, 5602 BD

Eindhoven, The Netherlands

For more information call:

In the U.S.A. (800) 443-5853 or

Fax (425) 446-5116

In Europe/M-East/Africa +31 (0) 40 2675 200 or

Fax +31 (0) 40 2675 222

In Canada (800)-36-FLUKE or

Fax (905) 890-6866

From other countries +1 (425) 446-5500 or

Fax +1 (425) 446-5116

Web access: <http://www.fluke.com>

©2010 Fluke Calibration.

Specifications subject to change without notice.

Printed in U.S.A. 8/2010 3031090B B-EN-N

Modification of this document is not permitted without written permission from Fluke Calibration.