

# Keysight E5061B-3L3/3L4/3L5 LF-RF Network Analyzer with Option 005 Impedance Analysis Function

Data Sheet

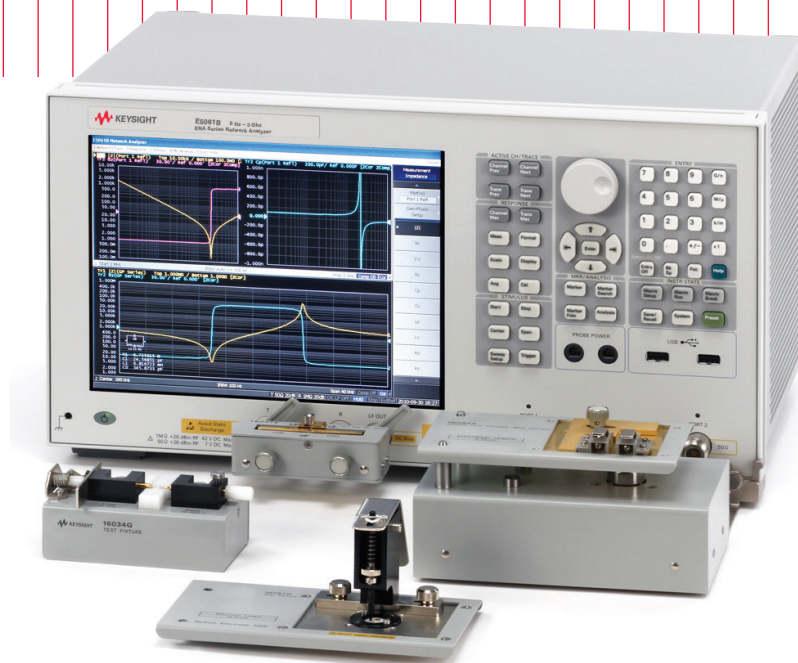

## E5061B-3L3/3L4/3L5 with Option 005; NA plus ZA in one box

To ensure the performance and reliability of electronic equipment, it is crucial to evaluate impedance characteristics of various electronic components used in the circuits. The E5061B-005 is the impedance analysis firmware option for the E5061B-3L3/3L4/3L5 ENA Series LF-RF network analyzer. The E5061B-005 combines network analysis (NA) and impedance analysis (ZA) functions in a single instrument with comprehensive component and circuit characterization in a broad frequency range, 5 Hz to 3 GHz.

E5061B-3L3/3L4/3L5 block diagram

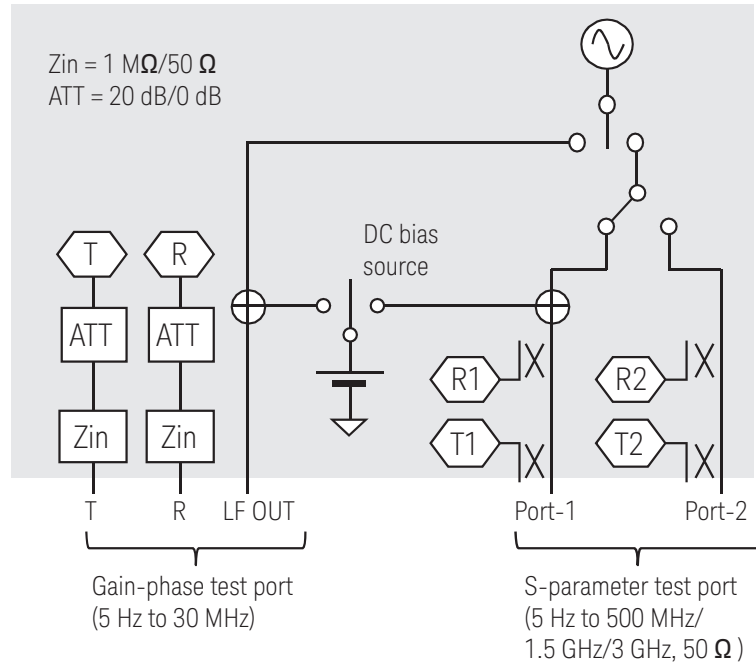

## Key measurement functions of E5061B-3L3/3L4/3L5 with Option 005

Impedance analysis functions	
Impedance parameters	$ Z , \theta_z,  Y , \theta_y, C_p, C_s, L_p, L_s, R_p, R_s, D, Q, R, X, G, B$
Measurement methods	Port 1 Reflection, Port 2 Reflection, Port 1-2 Series-thru, Port 1-2 Shunt-thru, Gain-phase Series-thru, Gain-phase Shunt-thru
Equivalent circuit analysis	3-component model (4 models: A/B/C/D), 4-component model (1 model: E)
Source characteristics	
Test frequency	5 Hz to 500 MHz/1.5 GHz/3 GHz (Port-1 and 2), 5 Hz to 30 MHz (Gain-Phase test port), 1 MHz resolution
AC source power (Osc level)	-45 to +10 dBm (when the source port is terminated with 50 Ω)
DC voltage bias	0 to ±40 V (100 mA max.) 1 mV resolution (0 V to ±10 V), 4 mV resolution (10 V to 40 V, -10 V to -40 V), DC bias monitor available (voltage or current)
Output impedance	50 Ω (nominal)
Sweep characteristics	
Sweep types	Linear frequency sweep, Logarithmic frequency sweep, Segment sweep, Power sweep (in dBm unit), DC bias sweep
Sweep direction	Up sweep
Number of point	2 to 1601
Error correction (for impedance measurements)	
Calibration	Impedance calibration (open/short/load and optional low-loss capacitor), Response thru calibration, Full 1-port calibration, Full 2-port calibration, ECal <sup>1</sup> , Port extensions.
Fixture compensation	Fixture selection (port extension for 7 mm fixtures), open/short/load compensation.

1. Applicable frequency is limited by the ECal used.

## Wide application coverage with three measurement techniques

To cover a broad range of impedance measurements for electronic components and circuits, the E5061B-005 supports three impedance measurement methods using both S-parameter and gain-phase test ports. You can choose appropriate measurement method depending on the impedance and frequency range of your application.

### Reflection method

The reflection method using the S-parameter port 1 is a general-purpose impedance measurement suitable for low-to-middle impedance range. Keysight's 7 mm component test fixtures can be connected via the 16201A 7 mm terminal adapter.

Similarly to conventional RF impedance analyzers, the measurement circuit is calibrated by performing the open/short/load (plus optional low-loss-C) calibration with the 7 mm calibration kit and eliminating errors caused by the 7 mm fixture with the fixture compensation functions (open/short compensation, plus optional fixture selection/port extension).

### Series-thru method

The series-thru method using the gain-phase test port is also a general-purpose impedance measurement, that is suitable for middle-to-high impedance range in the low frequency range up to 30 MHz.

You can connect Keysight's 4-terminal-pair (4TP) component test fixtures directly to the gain-phase test port. An accurate impedance measurement is obtained by performing the open/short/load calibration at the fixture with leaded or SMD 50 Ω resistors, which is provided by the option E5061B-720 50 ohm resistor set.



Port 1 reflection method using 16201A terminal adapter and 16092A 7 mm fixture

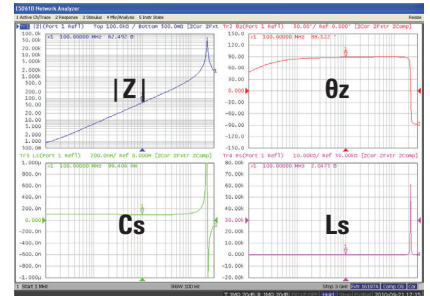

RF inductor measurement with reflection method (1 MHz to 3 GHz)

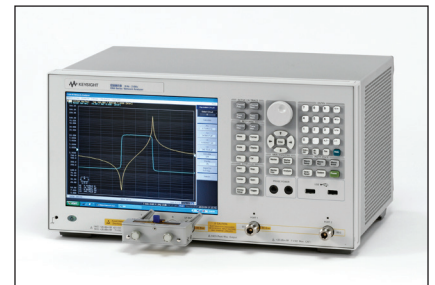

Gain-phase series-thru method using 16047E 4TP fixture

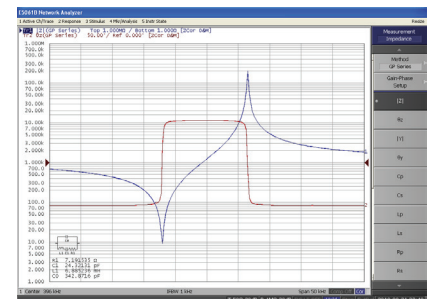

Ceramic resonator measurement with gain-phase series method ( $F_r = 400$  kHz)

## Shunt-thru method

The shunt-thru method is specifically targeted at very low impedance measurements down to milliohm range. The most typical applications are power distribution networks (PDNs) and their associated components such as bypass capacitors and DC-DC converters. The shunt-thru method using the S-parameter port 1 and 2 is suitable for PDN measurements up to GHz range. The shunt-thru method using the gain-phase test port is suitable for milliohm PDN measurements in the low frequency range, due to the ability to eliminate the ground loop errors.

Summary of major impedance measurement methods of the E5061B-3L3/3L4/3L5 + 005

	Typical freq. range	10% accuracy  Z  range	Test fixtures	Application examples
S-parameter port 1 reflection	5 Hz to 500 MHz /1.5 GHz/3 GHz	1 Ω to 2 kΩ	Keysight's 7 mm test fixtures with 16201A terminal adapter	Inductors, transformers, RF capacitors, RF diodes
Gain-phase series-thru (T: 50 Ω 20 dB, R: 1 MΩ 20 dB)	5 Hz to 30 MHz	3 Ω to 40 kΩ	Keysight's 4TP test fixtures	Resonators, piezo sensors, small capacitors, large inductors
S-parameter port 1-2 shunt-thru	100 kHz to 500 MHz /1.5 GHz/3 GHz <sup>1</sup>	1 mΩ to 80 Ω	User-prepared coax probes, or shunt-thru test board	High-freq PDN applications (bypass capacitors, PCB-level PDN measurements)
Gain-phase shunt-thru (T: 50 Ω 0 dB, R: 50 Ω 20 dB)	5 Hz to 30 MHz	<1 mΩ to 5 Ω	User-prepared coax probes, or shunt-thru test board	Low-freq PDN applications (DC-DC converters, large bypass caps, PCB-level PDN measurements)
S-parameter port 1-2 series-thru	5 Hz to 500 MHz /1.5 GHz/3 GHz	8 Ω to 40 kΩ	User prepared series-thru fixture	Resonators (Fr > 30 MHz)

1. Need external cores to measure milliohm impedance in the low frequency range below 100 kHz.

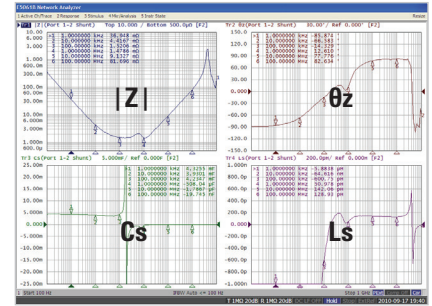
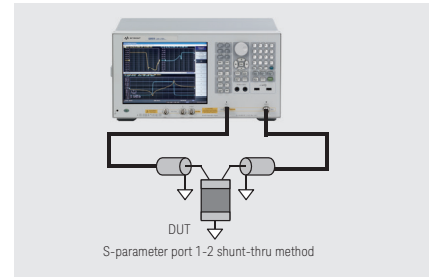

PDN measurement with S-parameter port 1-2 shunt-thru method (100 Hz to 1 GHz)

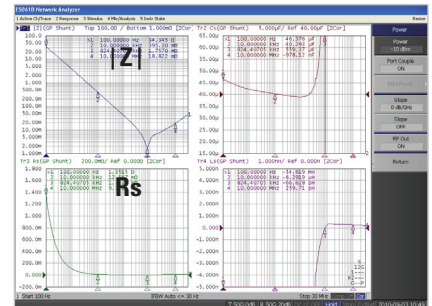
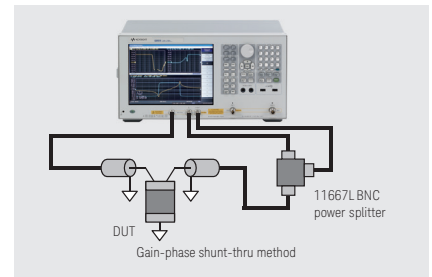

MLCC measurement with Gain-phase shunt-thru method (100 Hz to 30 MHz)

## Calibration and fixture compensation

### Impedance calibration

In addition to the NA calibration capabilities such as response-thru, 1-port full, and 2-port full, the E5061B-005 provides the impedance calibration (Z-calibration) function for impedance measurements. The impedance calibration executes the open/short/load (and optional low-loss-C) calibration in the impedance domain after the measured S-parameter or gain-phase ratio data is converted to impedance. This enables you to perform the open/short/load calibration in any impedance measurement method, not only in the reflection method but in the series-thru and shunt-thru methods.

### Fixture compensation

The fixture compensation functions eliminate the measurement errors introduced by test fixtures, and is mainly used in the reflection method using the 16201A terminal adapter and 7 mm test fixtures. The open/short (and optional load) compensation eliminates the fixture's residual impedance and stray admittance. The electrical length compensation (selecting fixture type, or Z port extension) eliminates the phase shift error that occurs at 7 mm fixtures in the RF range.

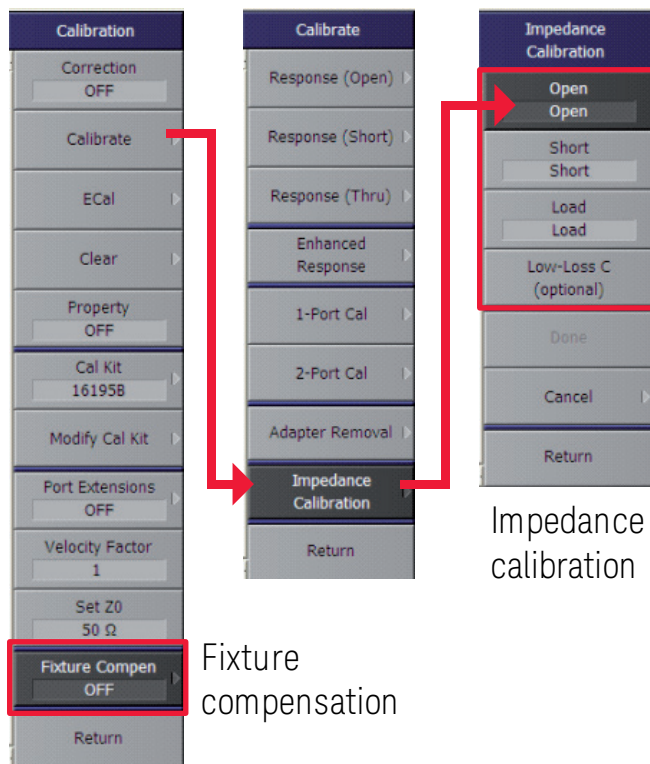

Impedance calibration

Fixture compensation

## Equivalent circuit analysis

The equivalent circuit analysis function extracts 3- or 4-element equivalent circuit parameters from the measured impedance trace for capacitors, inductors, and resonators. It is also possible to simulate the impedance curves using the extracted parameters and overlay them onto the measured impedance traces, while adjusting the value of each parameter to fit the simulated trace to the measured trace.

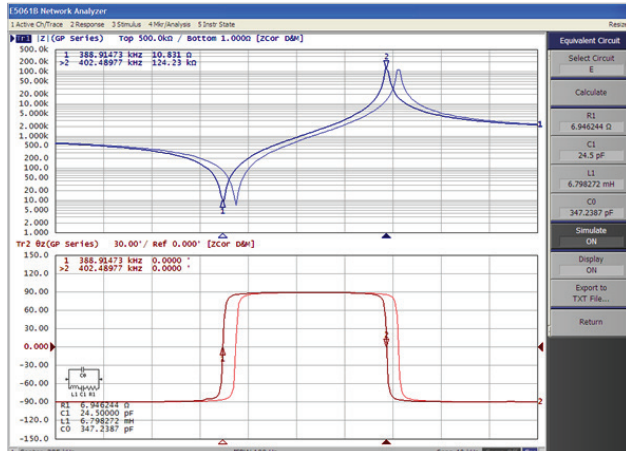

Equivalent circuit analysis (measured and simulated traces overlaid)

## DC biased impedance measurement

Unlike other network analyzers, the E5061B-3L3/3L4/3L5 is equipped with a built-in sweepable DC bias source (0 to 40 Vdc, max.100 mAdc) which superimposes a DC voltage onto the AC source signal at port 1 or LF OUT port. This enables you to easily perform DC voltage biased impedance measurements for components that have a DC bias dependency, such as varicap diodes, large-capacitance MLCCs, and MEMS resonators.

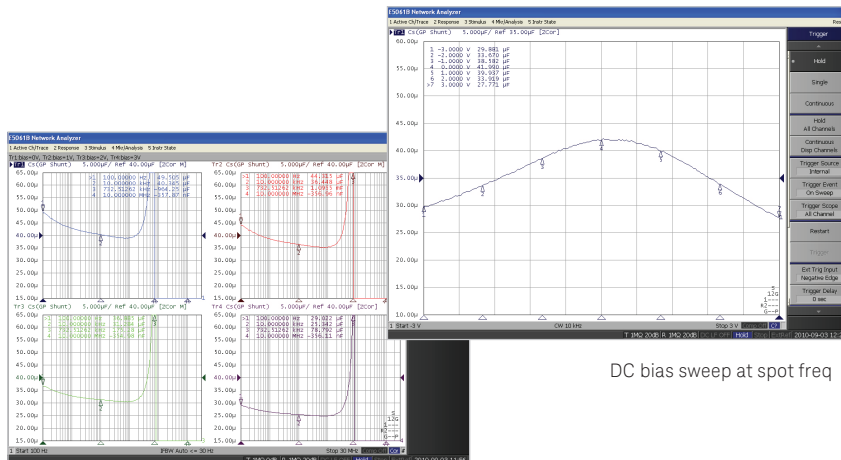

DC bias sweep at spot freq

Freq sweep with spot DC bias

DC voltage biased MLCC measurement

## Measurement Accuracy (SPD)

### Definition

All specifications apply over a 23°C ±5°C range (unless otherwise stated) and 90 minutes after the instrument has been turned on. Supplemental performance data (SPD) represents the value of a parameter that is most likely to occur; the expected mean or average. It is not guaranteed by the product warranty.

### Conditions for defining accuracy (Reflection and Series-thru method)

Common conditions

Frequency	5 Hz to 200 Hz	above 200 Hz
IFBW	≤ 1/5 x Frequency [Hz]	≤ 40 Hz
Averaging	OFF	
Temperature	Calibration is performed within 23 °C ±5 °C, measurement is performed within ±1 °C from the calibration temperature	

Reflection method

Measurement method	S-parameter port 1 reflection (Port 1 Refl)
Frequency range	5 Hz to 500 MHz/1.5 GHz/3 GHz
Calibration	Impedance calibration: Open/Short/Load <sup>1</sup>
Input Z	-
Input ATT	-
Source power	-20 to 0 dBm

Series-thru method

Frequency	S-parameter port 1-2 series-thru (Port 1-2 Series)	Gain-phase series-thru (GP Series)	
Frequency range	5 Hz to 500 MHz/1.5 GHz/3 GHz	5 Hz to 30 MHz	
Calibration	Full 2-port calibration: Open/Short/Load/Thru <sup>2</sup>	Impedance calibration: Open/Short/Load <sup>3</sup>	
Input Z	-	T: 50 Ω, R: 1 MΩ	T: 50 Ω, R: 1 MΩ
Input ATT	-	T: 20 dB, R: 20 dB	T: 0 dB, R: 0 dB
Source power	-20 to 0 dBm	-10 to 10 dBm	-30 to -10 dBm

1. At the 7 mm terminal of the 16201A with 7 mm calibration kit: 16195B or 85031B.
2. Without a Full 2-port calibration or a impedance calibration (Open / Short / Load) at the DUT connection terminal, a measurement accuracy may be degraded by a mismatch above 500 MHz.
3. At the end of the fixture: 16047E or 16034E/G/H, Load: 50 Ω resistor set (E5061B-720 or E5061-60109, Leaded 50 Ω or SMD 50 Ω). Only with the response-thru calibration at the end of the fixture, a measurement accuracy may be degraded by a parasitic capacitance of receiver port above 1 MHz.

## Conditions for defining accuracy (Shunt-thru method)

Common conditions

Frequency	5 Hz to 50 Hz	above 50 Hz
IFBW	$\leq 1/5 \times \text{Frequency [Hz]}$	$\leq 10 \text{ Hz}$
Averaging	OFF	
Temperature	Calibration is performed within $23 \text{ }^\circ\text{C} \pm 5 \text{ }^\circ\text{C}$ , Measurement is performed within $\pm 1 \text{ }^\circ\text{C}$ from the calibration temperature	

Shunt-thru method

Measurement method	S-parameter port 1-2 shunt-thru (Port 1-2 Shunt)	Gain-phase shunt-thru (GP Shunt)
Frequency range	100 kHz to 500 MHz/1.5 GHz/3 GHz <sup>1</sup>	5 Hz to 30 MHz
Calibration	Impedance calibration: Open/Short/Load <sup>2</sup>	Impedance calibration: Open/Short/Load with $-10 \text{ dBm}$ source power <sup>3</sup>
Input Z	-	T: $50 \text{ } \Omega$ , R: $50 \text{ } \Omega$
Input ATT	-	T: $0 \text{ dB}$ , R: $20 \text{ dB}$
Source power	$10 \text{ dBm}$	$10 \text{ dBm}$

1. Need external cores to measure milliohm impedance in the low frequency range below 100 kHz.
2. Without a Full 2-port calibration or a impedance calibration (Open/Short/Load) at the DUT connection terminal, a measurement accuracy may be degraded by a mismatch above 500 MHz.
3. Only with the response-thru calibration at the DUT connection terminal, a measurement accuracy may be degraded by a parasitic capacitance of receiver port above 1 MHz.

## Impedance measurement accuracy comparison with the 4395A (SPD)

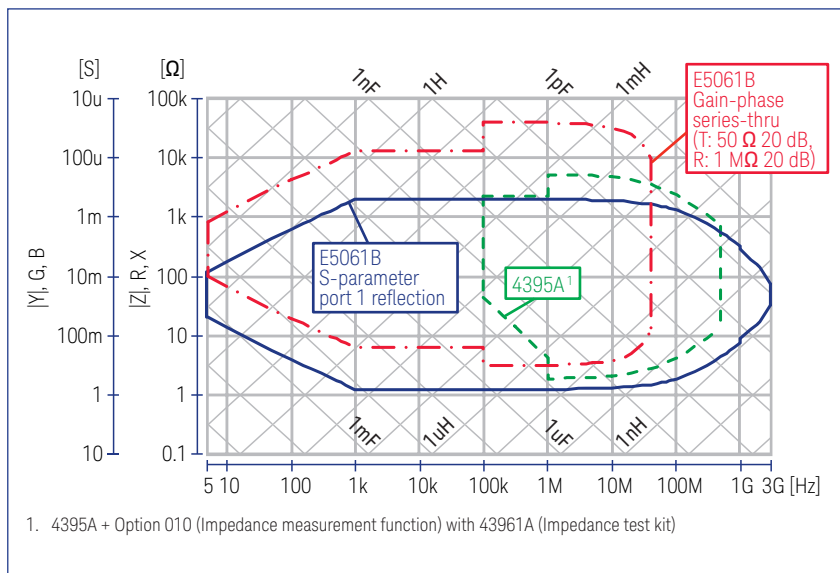

Figure 1. Impedance measurement accuracy (SPD)  $\leq 10\%$ . Comparison with 4395A.



## Impedance measurement accuracy (SPD) (continued)

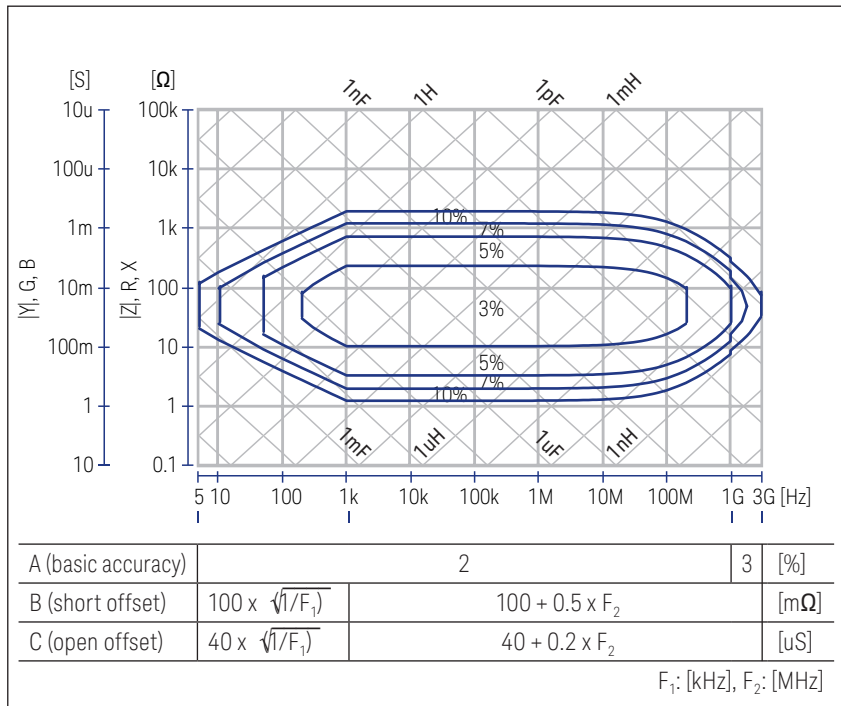

Figure 2. Impedance measurement accuracy (SPD), S-parameter port 1 reflection method.

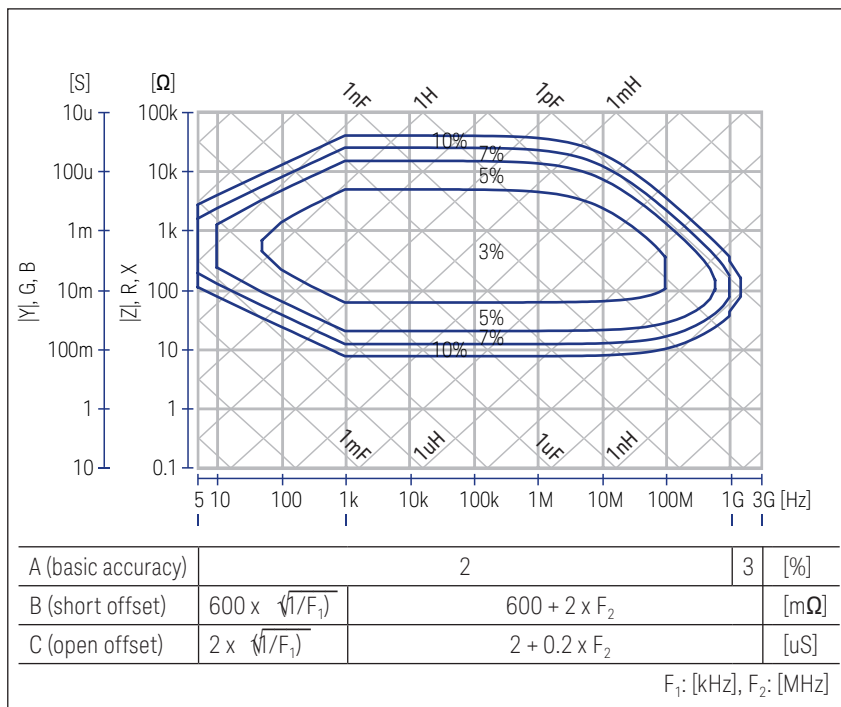

Figure 3. Impedance measurement accuracy (SPD), S-parameter port 1-2 series-thru method.

Impedance measurement accuracy (SPD) (continued)

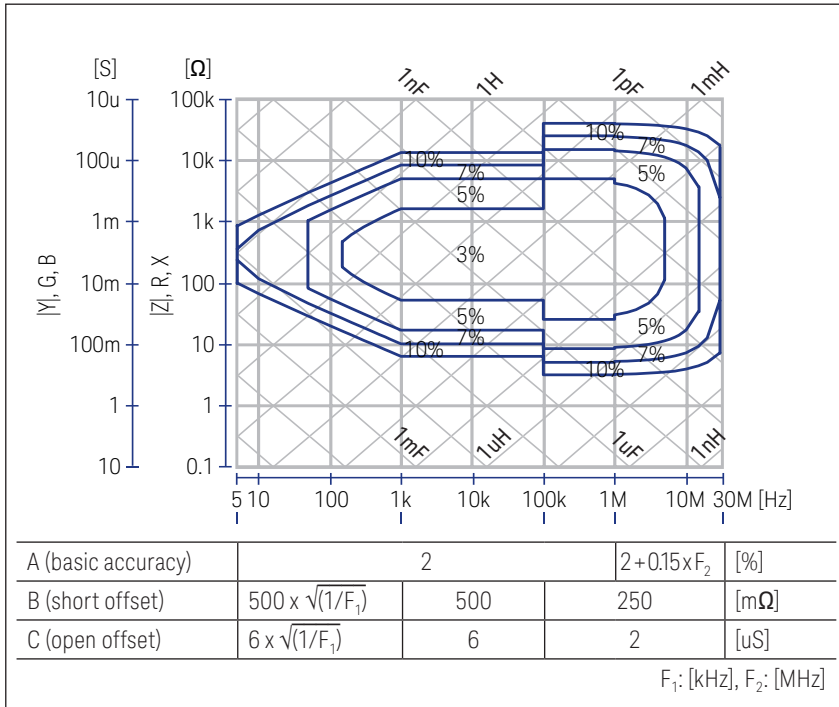

Figure 4. Impedance measurement accuracy (SPD), Gain-phase series-thru method (T: 50 Ω 20 dB, R: 1 MΩ 20 dB).

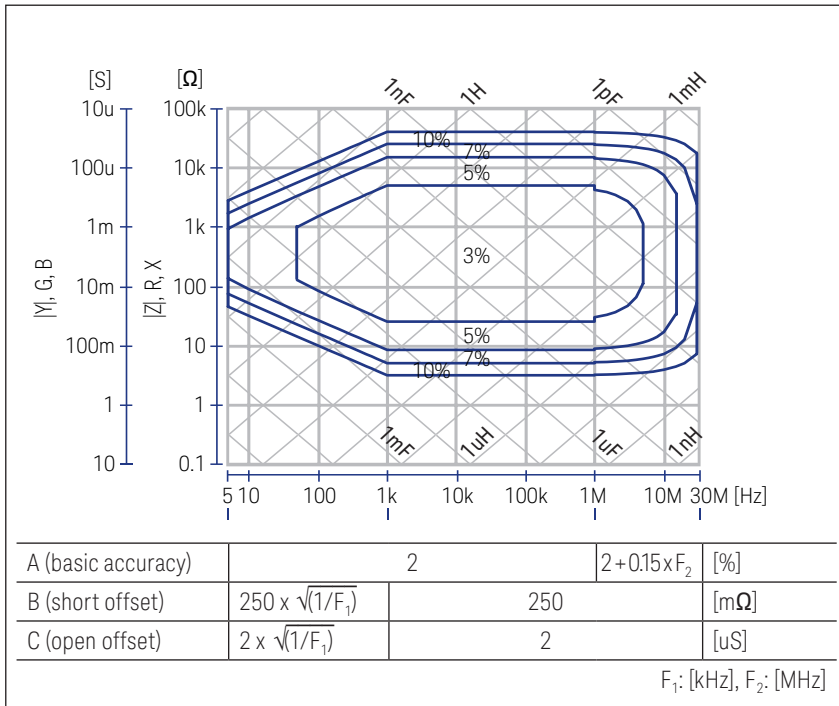

Figure 5. Impedance measurement accuracy (SPD), Gain-phase series-thru method (T: 50 Ω 0 dB, R: 1 MΩ 0 dB).

## Impedance measurement accuracy (SPD) (continued)

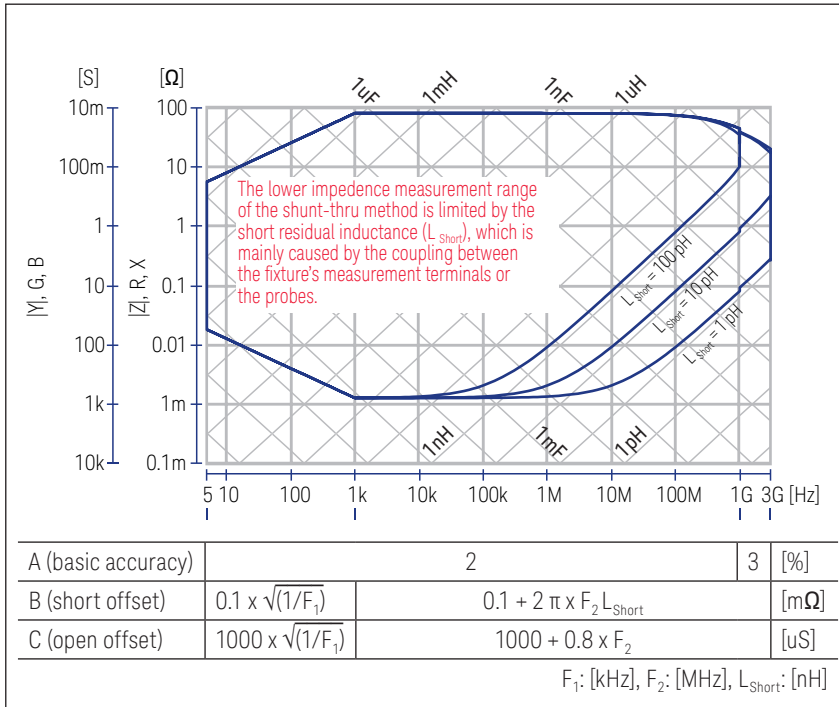

Figure 6. Impedance measurement accuracy (SPD)  $\leq 10\%$ , S-parameter port 1-2 shunt-thru method.

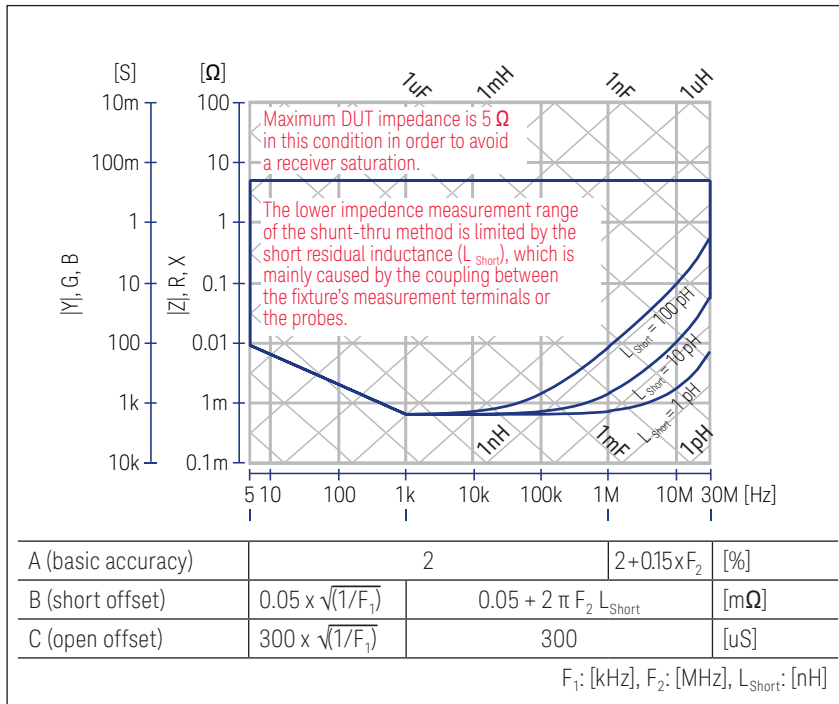

Figure 7. Impedance measurement accuracy (SPD)  $\leq 10\%$ , Gain-phase shunt-thru method (T: 50 Ω 0 dB, R: 50 Ω 20 dB).

## Impedance measurement accuracy (SPD) (continued)

In the following equations, A, B, and C are obtained from Figure 1 to Figure 6.

<b> Z  - <math>\theta_z</math> accuracy</b>	
Z	$A + (B/ Z_m  + C \times  Z_m ) \times 100$ [%]
$\theta_z$	$\sin^{-1}(Z_a/100)$ [rad]

Where,  $Z_a$  is |Z| accuracy.  $|Z_m|$  is |Z| measured.

<b> Y  - <math>\theta_y</math> accuracy</b>	
Y	$A + (B \times  Y_m  + C/ Y_m ) \times 100$ [%]
$\theta_y$	$\sin^{-1}(Y_a/100)$ [rad]

Where,  $Y_a$  is |Y| accuracy.  $|Y_m|$  is |Y| measured.

<b>R - X accuracy (depends on D)</b>			
	<b><math>D \leq 0.2</math></b>	<b><math>0.2 &lt; D \leq 5</math></b>	<b><math>5 &lt; D</math></b>
R	$\pm X_m \times X_a / 100$ [ $\Omega$ ]	$R_a / \cos\theta$ [%]	$R_a$ [%]
X	$X_a$ [%]	$X_a / \sin\theta$ [%]	$\pm R_m \times R_a / 100$ [ $\Omega$ ]

Where,  $R_a = A + (B/|R_m| + C \times |R_m|) \times 100$  [%],  $X_a = A + (B/|X_m| + C \times |X_m|) \times 100$  [%]  $R_m$  and  $X_m$  are the measured R and X respectively.

<b>G - B accuracy (depends on D)</b>			
	<b><math>D \leq 0.2</math></b>	<b><math>0.2 &lt; D \leq 5</math></b>	<b><math>5 &lt; D</math></b>
G	$\pm B_m \times B_a / 100$ [ $\Omega$ ]	$G_a / \cos\theta$ [%]	$G_a$ [%]
B	$B_a$ [%]	$B_a / \sin\theta$ [%]	$\pm G_m \times G_a / 100$ [ $\Omega$ ]

Where,  $G_a = A + (B/|G_m| + C \times |G_m|) \times 100$  [%],  $B_a = A + (B/|B_m| + C \times |B_m|) \times 100$  [%]  $G_m$  and  $B_m$  are the measured G and B respectively.

<b>D accuracy (depends on D)</b>		
	<b><math>D \leq 0.2</math></b>	<b><math>0.2 &lt; D</math></b>
D	$Z_a/100$	$(Z_a/100) \times (1+D^2)$

Where,  $Z_a$  is |Z| accuracy.

<b>L accuracy (depends on D)</b>		
	<b><math>D \leq 0.2</math></b>	<b><math>0.2 &lt; D</math></b>
L	$L_a$	$L_a \times (1+D)$

Where,  $L_a = A + (B/|Z_L| + C \times |Z_L|) \times 100$  [%]  
 $|Z_L| = 2 \pi f \times L_m$ , f is frequency in Hz, and  $L_m$  is measured L.

<b>C accuracy (depends on D)</b>		
	<b><math>D \leq 0.2</math></b>	<b><math>0.2 &lt; D</math></b>
C	$C_a$	$C_a \times (1+D)$

Where,  $C_a = A + (B/|Z_C| + C \times |Z_C|) \times 100$  [%]  
 $|Z_C| = (2 \pi f \times C_m)^{-1}$ , f is frequency in Hz, and  $C_m$  is measured C.

Must order the following options for the impedance measurement on the E5061B.

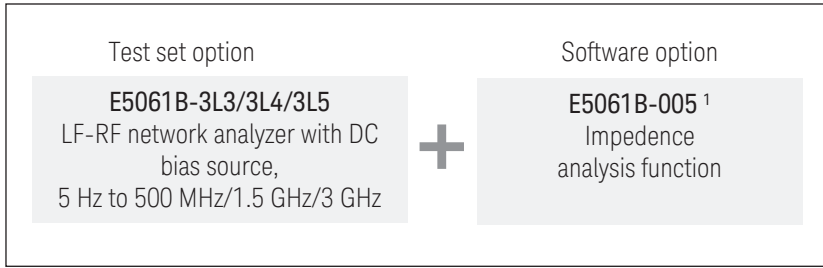

### Typical configuration examples

S-parameter port 1 reflection method (for low-mid impedance, up to 3 GHz)

E5061B options	
E5061B	Network Analyzer
E5061B-3L5	LF-RF NA with DC bias
E5061B-005	Impedance analysis function for LF-RF NA
E5061B-1E5	High stability time base
E5061B-020	Standard hard disk drive
E5061B-810	Add key board
E5061B-820	Add mouse
Adapter for connecting fixtures	
16201A	7 mm terminal adapter kit
16201A-001 <sup>2</sup>	7 mm terminal adapter kit for E5061B
7 mm calibration kit	
16195B (open/short/load + low-loss capacitor)	
7 mm test fixtures	
16092A (SMD & leaded component, 500 MHz)	

1. E5061B-005 is not applicable to the E5061B RF NA option: 1x5 / 2x5 / 1x7 / 2x7.
2. Option 001 is the only option for the 16201A. Must choose this option when ordering the 16201A.



16201A



16201A

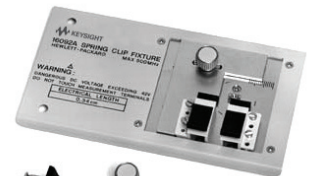

16092A

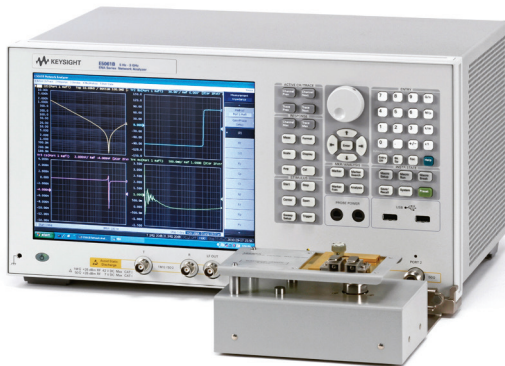

Gain-phase series-thru method (for mid-high impedance, up to 30 MHz)

**E5061B options**

E5061B	Network Analyzer
E5061B-3L5	LF-RF NA with DC bias
E5061B-005	Impedance analysis function for LF-RF NA
E5061B-720	50 Ω resistor set

50 Ω resistor set contains the following items for the impedance calibration at the test fixture:

- SMD 50 Ω (0699-2929), 10 ea
- Leaded 50 Ω (5012-8646), 2 ea
- Tweezers (8710-2018), 1 ea

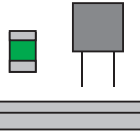

16047E



16034E

E5061B-1E5	High stability time base
E5061B-020	Standard hard disk drive
E5061B-810	Add key board
E5061B-820	Add mouse

**4-terminal pair test fixtures**

16047E (leaded component)
16034E (SMD), or 16034G (for SMD)

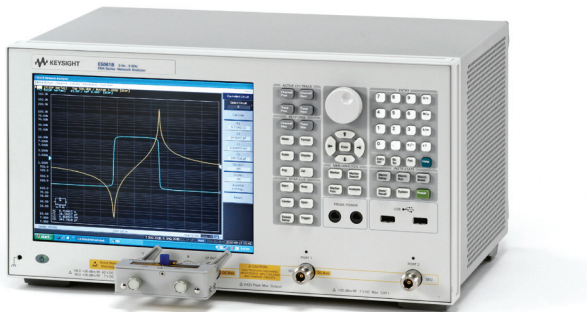

## Upgrade kit

The following upgrade kits are available for adding the option 005 and 720 to the E5061B-3L3/3L4/3L5.

<b>Software upgrade</b>		
<b>Upgrade kit No. (Order with this No.)</b>	<b>Description</b>	<b>Option No.</b>
E5007A	Impedance analysis for E5061B-3L3/3L4/3L5 LF-RF network analyzer	E5061B-005
E5007A-1FP <sup>1</sup>	Fixed Perpetual license	
<b>Impedance accessory</b>		
E5061-60109	50 $\Omega$ resistor set (Equivalent to E5061B-720)	E5061B-720

1. This option is not applicable to the E5061B RF NA options 1x5/1x7/2x5/2x7. If your E5061B's firmware revision is Rev.A.01.xx, the firmware must be updated to Rev.A.02.00 or later before installing the impedance analysis firmware option.

## Available accessories

<b>7 mm calibration kit (for S-parameter port 1 reflection method with 16201A)</b>		
<b>Model No.</b>	<b>Frequency</b>	<b>Description, Additional Information</b>
16195B	DC to 3 GHz	7-mm calibration kit. Contains Open, Short, 50 $\Omega$ Load and Low-loss capacitor terminations.
85031B	DC to 6 GHz	7-mm calibration kit. Contains Open, Short and 50 $\Omega$ Load terminations.
<b>7 mm test fixture (for S-parameter port 1 reflection method with 16201A)</b>		
16092A	DC to 500 MHz	Spring clip test fixture for SMD and leaded device.
16197A	DC to 3 GHz	For bottom electrode SMD from 1005 (mm)/0402 (inch) to 3225 (mm)/1210 (inch).
16192A	DC to 2 GHz	For parallel electrode SMD.
16196A	DC to 3 GHz	For parallel electrode SMD, 1608 (mm)/0603 (inch).
16196B	DC to 3 GHz	For parallel electrode SMD, 1005 (mm)/0402 (inch).
16196C	DC to 3 GHz	For parallel electrode SMD, 0603 (mm)/0201 (inch).
16196D	DC to 3 GHz	For parallel electrode SMD, 0402 (mm)/01005 (inch).
16194A	DC to 2 GHz	High Temperature Component Test Fixture for SMD and leaded device, Temperature range: -55 °C to +200 °C.
<b>4-terminal pair test fixture (for Gain-phase series-thru method)</b>		
16047E	DC to 110 MHz	For axial or radial lead device.
16034E	DC to 40 MHz	For SMD, (0.1 to 8) L x (0.5 to 10) W x (0.5 to 10) H in mm.
16034G	DC to 110 MHz	For SMD, (0.1 to 5) L x (0.3 to 1.6) W x (0.3 to 1.6) H in mm.
16034H	DC to 110 MHz	For array-type SMD, (0.1 to 5) L x ( $\leq$ 15) W x (0.6 to 3) H in mm.
<b>Other accessories</b>		
11667L	DC to 2 GHz	Power splitter with BNC connector for gain-phase shunt-thru method. Used for milliohm PDN measurement at low frequencies.
16200B	1 MHz to 1 GHz	DC bias adaptor, it allows you to supply a bias current across the device of up to 5 Adc through a 7 mm port by using an external dc current source.



11667L

## Literature Resources

You can find information about key features, technical specifications, and option configurations for the E5061B's network analysis in the following documents:

*Keysight E5061B Network Analyzer Brochure* **5990-6794EN**

*Keysight E5061B Network Analyzer Data Sheet* **5990-4392EN**

*Keysight E5061B Network Analyzer Configuration Guide* **5990-4391EN**

For more detailed information about impedance measurement basics and technical specifications of test fixtures, refer to the following documents:

*Keysight Impedance Measurement Handbook* **5950-3000**

*Keysight Accessories Selection Guide for Impedance Measurements* **5965-4792EN**

## Web Resources

Have access to the following website to acquire the latest news, product and support information, application literature and more: [www.keysight.com/find/e5061b](http://www.keysight.com/find/e5061b)



## From Hewlett-Packard through Agilent to Keysight

For more than 75 years, we've been helping you unlock measurement insights. Our unique combination of hardware, software and people can help you reach your next breakthrough. **Unlocking measurement insights since 1939.**

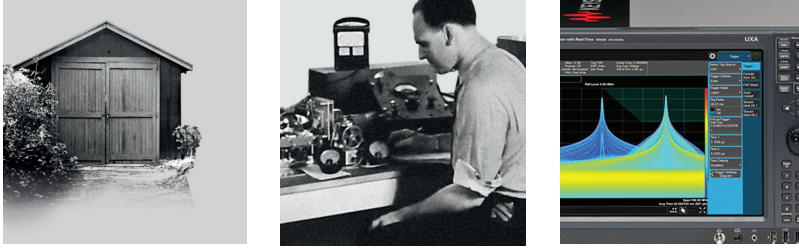

1939

THE FUTURE

For more information on Keysight Technologies' products, applications or services, please contact your local Keysight office. The complete list is available at: [www.keysight.com/find/contactus](http://www.keysight.com/find/contactus)

### Americas

Canada	(877) 894 4414
Brazil	55 11 3351 7010
Mexico	001 800 254 2440
United States	(800) 829 4444

### Asia Pacific

Australia	1 800 629 485
China	800 810 0189
Hong Kong	800 938 693
India	1 800 11 2626
Japan	0120 (421) 345
Korea	080 769 0800
Malaysia	1 800 888 848
Singapore	1 800 375 8100
Taiwan	0800 047 866
Other AP Countries	(65) 6375 8100

### Europe & Middle East

Austria	0800 001122
Belgium	0800 58580
Finland	0800 523252
France	0805 980333
Germany	0800 6270999
Ireland	1800 832700
Israel	1 809 343051
Italy	800 599100
Luxembourg	+32 800 58580
Netherlands	0800 0233200
Russia	8800 5009286
Spain	800 000154
Sweden	0200 882255
Switzerland	0800 805353
	Opt. 1 (DE)
	Opt. 2 (FR)
	Opt. 3 (IT)
United Kingdom	0800 0260637

For other unlisted countries: [www.keysight.com/find/contactus](http://www.keysight.com/find/contactus) (BP-02-10-16)



[www.keysight.com/go/quality](http://www.keysight.com/go/quality)  
 Keysight Technologies, Inc.  
 DEKRA Certified ISO 9001:2015  
 Quality Management System

### myKeysight

### myKeysight

[www.keysight.com/find/mykeysight](http://www.keysight.com/find/mykeysight)

A personalized view into the information most relevant to you.

### Three-Year Warranty



[www.keysight.com/find/ThreeYearWarranty](http://www.keysight.com/find/ThreeYearWarranty)

Keysight's committed to superior product quality and lower total cost of ownership. Keysight is the only test and measurement company with three-year warranty standard on all instruments, worldwide. And, we provide a one-year warranty on many accessories, calibration devices, systems and custom products.

### Keysight Assurance Plans



[www.keysight.com/find/AssurancePlans](http://www.keysight.com/find/AssurancePlans)

Up to ten years of protection and no budgetary surprises to ensure your instruments are operating to specification, so you can rely on accurate measurements.

### Keysight Infoline

### Keysight Infoline

[www.keysight.com/find/service](http://www.keysight.com/find/service)

Keysight's insight to best in class information management. Free access to your Keysight equipment company reports and e-library.

### Keysight Channel Partners

[www.keysight.com/find/channelpartners](http://www.keysight.com/find/channelpartners)

Get the best of both worlds: Keysight's measurement expertise and product breadth, combined with channel partner convenience.



Unlocking Measurement Insights

This information is subject to change without notice.  
 © Keysight Technologies, 2013 – 2016  
 Published in USA, March 25, 2016  
 5990-7033EN  
[www.keysight.com](http://www.keysight.com)