

Process Calibrator
CA300 series



Process Calibrator

CA300 series

Source and Measure Simplicity

Bulletin CA300-EN

www.yokogawa.com/yml

vigilantplant.[®]
The clear path to operational excellence

YOKOGAWA 

Specialized high performance model for Loop Inspection!



Volt mA Calibrator CA310

■ Features

- Basic accuracy: 0.015% (Source&Meas. accuracy of Voltage mA)
- 20mA SIMULATE (SINK) function
- Simultaneously supplies 24V loop power and measure output signal with high accuracy
- HART/BRAIN comm. resistance (250Ω) embedded
- Sub display displays span (%) of the source value
- Corresponds to various types of source pattern (Step sweep/ Linear sweep/ Manual step/ Span check)

Useful function installed

■ Addition of sub display

The sub display additionally displays span (%), source value of voltage or resistance, while the main displays setting value.



■ Corresponds to 2WAY Power supply

Power is supplied by 2 ways :
AA Alkaline batteries or AC Adapter



AC Adapter is sold separately



Specialized high performance model for TC simulate and RTD simulate!



TC Calibrator **CA320**

■ Features

- Basic accuracy: 0.5°C (Typical of TC type K)
*Including accuracy of internal RJC
- Corresponds to 16 types of TC standard (JIS/IEC/DIN/ASTM/GOST R)
- Sub display displays value of voltage source and span (%)
- Corresponds to various types of source pattern (Step sweep/ Linear sweep/ Manual step/ Span check)
- Corresponds to other TC types by mV source function
- Measures TC sensor output as a thermometer



RTD Calibrator **CA330**

■ Features

- Basic accuracy: 0.3°C (Typical of Pt100)
- Corresponds to 14 types of RTD standard (JIS/IEC/GOST R)
- Sub display displays value of resistance source and span (%)
- Corresponds to various types of source pattern (Step sweep/ Linear sweep/ Manual step/ Span check)
- Corresponds to 2,3,4 wire. Realizes RTD simulation
- Measures output of RTD sensor as a thermometer

Supports efficient operation with various types of source pattern

■ Step sweep function

Sources by 25% step automatically from 0% to 100% of span which improves efficiency of operation. It can correspond to various response time of field devices. (15/30/45/60 seconds)

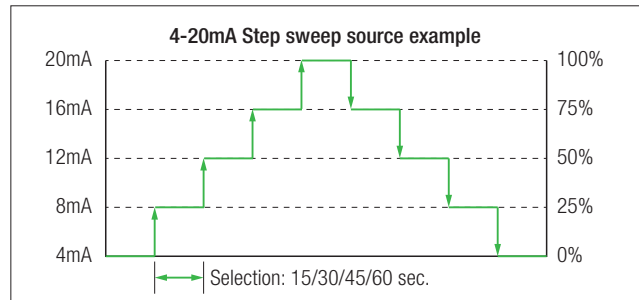

■ Manual step function

Sources by 25% step manually from 0% to 100% of span. Users can do step sourcing at arbitrary timing corresponding to situations.

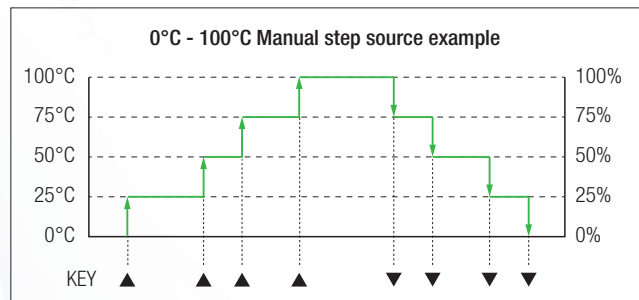

■ Linear sweep function

Sources continuously from 0% to 100% and is capable to check meter and make linearity tests. Sweep time can be selected by 15/30/45/60 seconds.

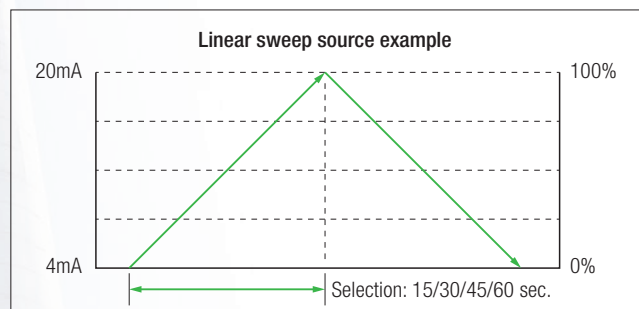

■ Span check function

Switches sources 0% ⇌ 100% by one touch. With this function, it makes it simple to make adjustment and to inspect the open and close operation of valves.

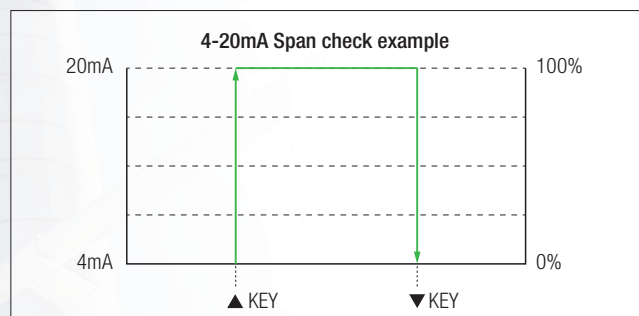



Corresponds to various application

■ 20mA SIMULATE

CA310 is capable to execute a loop check by simulating a transmitter, sinking the current signal from the external source (distributor). It achieves the high accuracy 0.015% of setting to source 4-20mA.

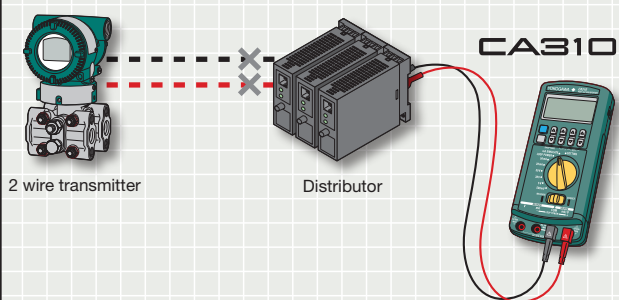

■ Two-wire Transmitter Loop Check

DC mA signals can be measured by supplying power to the transmitter from a 24 V DC power supply. DC mA measurement and zero-point check can be performed with an accuracy of 0.015% of reading. A 250-ohm resistor for HART and BRAIN communication is included in this calibrator so there is no need to attach an external resistor when connecting to a handy terminal.

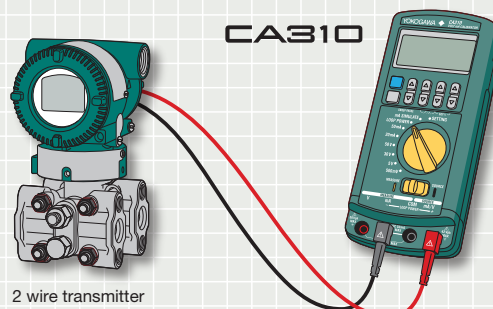

■ TC SIMULATE

CA320 corresponds to 16 types of TC for sourcing. It achieves the high basic accuracy of 0.5°C (typical of type K), three times better than the previous model which enables it to operate a highly reliable test. Additionally, the difference of temperature between objects can be compensated, by using external RJ sensor or a compensating lead wire.

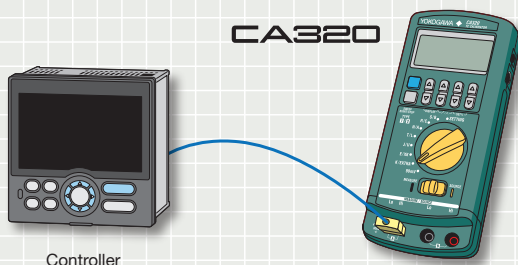

■ TC MEASURING

CA320 can measure the output of TC like a thermometer. It achieves the basic accuracy of 0.5°C (typical of type K), three times better than the previous model and is for multiple use for process temperature measuring by corresponding to 16 types of TC.

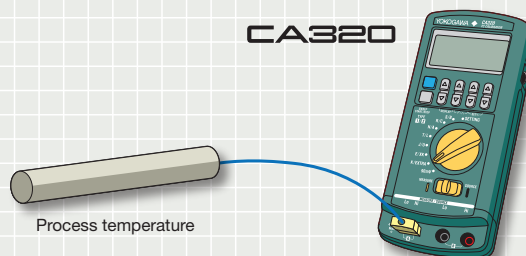

■ RTD SIMULATE

CA330 corresponds to 14 types of RTD for sourcing. It achieves the high basic accuracy of 0.3°C (typical of type Pt100), twice better than the previous model which enables it to operate a high reliable test.

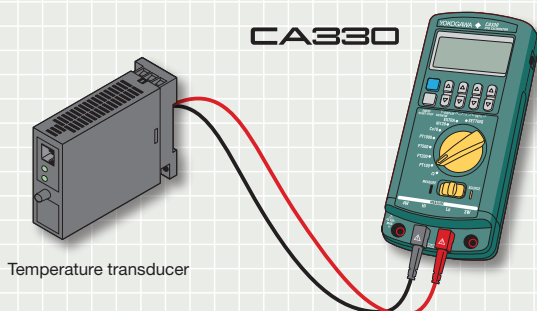

■ RTD MEASURING

CA330 can measure the output of RTD like a thermometer. It achieves the basic accuracy of 0.3°C (typical of type Pt100), twice better than the previous model and is for multiple use of process temperature measuring by corresponding to 14 types of RTD.

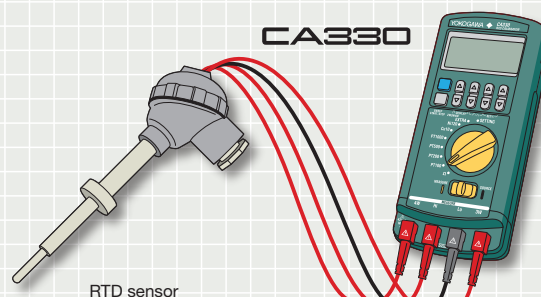

■ Basic Specification (Source function) CA310

DC Current source

Range	Resolution	Source range	Accuracy (1 year)	Note
20mA	1μA	0.000 to 24.000mA	0.015% of setting+3μA	Compliance voltage: 24V
20mA SIMULATE	1μA	0.000 to 24.000mA	0.015% of setting+3μA	External power supply: 5V to 28V

DC Voltage source

Range	Resolution	Source range	Accuracy (1 year)	Note
500mV	10μV	0.00 to 550.00mV	0.015% of setting+50μV	Max. current: 10mA
5V	0.1mV	0.0000 to 5.5000V	0.015% of setting+0.5mV	Max. current: 10mA
30V	1mV	0.000 to ±33.000V	0.015% of setting+5mV	Max. current: 1mA

Accuracy is specified at ambient temperature(Ta) of :23±5°C
 Temperature effect: 0.005% or Range/°C is added for other ambient temperature (Ta < 18°C, Ta > 28°C)

■ Basic Specification (Measurement function) CA310

DC Current measurement

Range	Resolution	Measurement range	Accuracy (1 year)	Note
20mA	1μA	0 to ±24.000mA	0.015% reading+3μA	Input resistance: less than 10Ω
50mA	1μA	0 to ±60.000mA	0.015% reading+3μA	

DC Voltage measurement

Range	Resolution	Measurement range	Accuracy (1 year)	Note
500mV	10μV	0 to ±550.00mV	0.015% of reading+50μV	Input resistance: approx. 1MΩ
5V	0.1mV	0 to ±5.5000V	0.015% of reading+0.5mV	Input resistance: approx. 1MΩ
30V	1mV	0 to ±33.000V	0.015% of reading+5mV	Input resistance: approx. 1MΩ
50V	1mV	0 to ±55.000V	0.015% of reading+5mV	Input resistance: approx. 1MΩ

24V Loop Power Supply

Range	Supply voltage	Note
Loop Power	24V±1V	Communication resistance OFF: load current 24mA
	24V±6V	Communication resistance ON: load current 20mA

Accuracy is specified at ambient temperature(Ta) of :23±5°C
 Temperature effect: 0.005% or Range/°C is added for other ambient temperature (Ta < 18°C, Ta > 28°C)

■ Measurement Unit Common Specifications

- CMRR approx. 120dB (50/60Hz)
- NMRR approx. 60dB (50/60Hz)
- Measurement terminal maximum input:
 - Voltage terminal DC 50V
 - Current terminal 60mA
- Current terminal protective input: PTC protection
- Maximum allowable applied voltage: Measure terminal to ground 50V peak

■ Generation Unit Common Specifications

- Generation unit voltage limiter: Approx. 36 V
- Generation unit current limiter: Approx. 30 mA
- Sweep function Step (25%)/ Linear
- Step time 15sec/30sec/45sec/60sec
- Generation load condition: C < 0.1μF, L < 10mH
- Output resistance: under 10mΩ
- Output response time: under 300ms
- Maximum allowable applied voltage: Source terminal to ground 42V peak



■ Basic specification (Source/ Measure) CA320

Thermocouple (TC) Source/Measure (Terminal A: TC plug terminal)

t: Temperature of Source/Meas.

TC	Accuracy (1 year)			Standard or Regulation	
	Source/Meas. Temperature	Source Accuracy [°C]	Meas. Accuracy [°C]		
K	$-200.0^{\circ}\text{C} \leq t < 0.0^{\circ}\text{C}$	$0.5 + t \times 0.3\%$	$0.5 + t \times 0.3\%$	IEC60584-1 JIS C1602	
	$0.0^{\circ}\text{C} \leq t < +500.0^{\circ}\text{C}$	0.5	0.5		
	$+500.0^{\circ}\text{C} \leq t \leq +1372.0^{\circ}\text{C}$	$0.5 + (t - 500) \times 0.03\%$	$0.5 + (t - 500) \times 0.02\%$		
E	$-250.0^{\circ}\text{C} \leq t < -200.0^{\circ}\text{C}$	$1.1 + (t - 200) \times 2.0\%$	$1.1 + (t - 200) \times 2.0\%$	IEC60584-1	
	$-200.0^{\circ}\text{C} \leq t < 0.0^{\circ}\text{C}$	$0.5 + t \times 0.3\%$	$0.5 + t \times 0.3\%$		
	$0.0^{\circ}\text{C} \leq t < +500.0^{\circ}\text{C}$	0.5	0.5		
J	$+500.0^{\circ}\text{C} \leq t \leq +1000.0^{\circ}\text{C}$	$0.5 + (t - 500) \times 0.02\%$	$0.5 + (t - 500) \times 0.02\%$	IEC60584-1	
	$-210.0^{\circ}\text{C} \leq t < 0.0^{\circ}\text{C}$	$0.5 + t \times 0.3\%$	$0.5 + t \times 0.3\%$		
	$0.0^{\circ}\text{C} \leq t \leq +1200.0^{\circ}\text{C}$	$0.5 + t \times 0.02\%$	$0.5 + t \times 0.02\%$		
T	$-250.0^{\circ}\text{C} \leq t < -200.0^{\circ}\text{C}$	$1.1 + (t - 200) \times 2.5\%$	$1.1 + (t - 200) \times 2.5\%$	IEC60584-1	
	$-200.0^{\circ}\text{C} \leq t < 0.0^{\circ}\text{C}$	$0.5 + t \times 0.3\%$	$0.5 + t \times 0.3\%$		
	$0.0^{\circ}\text{C} \leq t \leq +400.0^{\circ}\text{C}$	0.5	0.5		
N	$-200.0^{\circ}\text{C} \leq t < 0.0^{\circ}\text{C}$	$0.6 + t \times 0.4\%$	$0.6 + t \times 0.3\%$	IEC60584-1	
	$0.0^{\circ}\text{C} \leq t \leq +1300.0^{\circ}\text{C}$	0.6	0.6		
	$-200.0^{\circ}\text{C} \leq t < 0.0^{\circ}\text{C}$	$0.5 + t \times 0.15\%$	$0.5 + t \times 0.15\%$		
L	$0.0^{\circ}\text{C} \leq t \leq +900.0^{\circ}\text{C}$	0.5	0.5	DIN 43710	
	$-200.0^{\circ}\text{C} \leq t < 0.0^{\circ}\text{C}$	$0.5 + t \times 0.2\%$	$0.5 + t \times 0.2\%$		
	$0.0^{\circ}\text{C} \leq t \leq +600.0^{\circ}\text{C}$	0.5	0.5		
R	$-20.0^{\circ}\text{C} \leq t < 0.0^{\circ}\text{C}$	2.0	2.0	IEC60584-1	
	$0.0^{\circ}\text{C} \leq t < +100.0^{\circ}\text{C}$	2.0	1.4		
	$+100.0^{\circ}\text{C} \leq t \leq +1767.0^{\circ}\text{C}$	1.4	1.4		
S	$-20.0^{\circ}\text{C} \leq t < 0.0^{\circ}\text{C}$	2.0	2.0	IEC60584-1	
	$0.0^{\circ}\text{C} \leq t < +100.0^{\circ}\text{C}$	2.0	1.4		
	$+100.0^{\circ}\text{C} \leq t \leq +1768.0^{\circ}\text{C}$	1.4	1.4		
B	$+600.0^{\circ}\text{C} \leq t < +800.0^{\circ}\text{C}$	1.2	1.5	IEC60584-1	
	$+800.0^{\circ}\text{C} \leq t < +1000.0^{\circ}\text{C}$	1.0	1.2		
	$+1000.0^{\circ}\text{C} \leq t \leq +1820.0^{\circ}\text{C}$	1.0	1.1		
C	$0.0^{\circ}\text{C} \leq t < +1000.0^{\circ}\text{C}$	0.8	0.8	IEC60584-1	
	$+1000.0^{\circ}\text{C} \leq t \leq +2315.0^{\circ}\text{C}$	$0.8 + (t - 1000) \times 0.06\%$	$0.8 + (t - 1000) \times 0.06\%$		
	$-200.0^{\circ}\text{C} \leq t < 0.0^{\circ}\text{C}$	$0.4 + t \times 0.2\%$	$0.4 + t \times 0.2\%$		
XK	$0.0^{\circ}\text{C} \leq t < +300.0^{\circ}\text{C}$	0.4	0.4	GOST R 8.585-2001	
	$+300.0^{\circ}\text{C} \leq t \leq +800.0^{\circ}\text{C}$	0.5	0.5		
	$0.0^{\circ}\text{C} \leq t < +1000.0^{\circ}\text{C}$	1.0	1.0		
A	$+1000.0^{\circ}\text{C} \leq t \leq +2500.0^{\circ}\text{C}$	$1.0 + (t - 1000) \times 0.06\%$	$1.0 + (t - 1000) \times 0.06\%$	IEC60584-1	
	$0.0^{\circ}\text{C} \leq t < +300.0^{\circ}\text{C}$	1.4	1.8		
	$+300.0^{\circ}\text{C} \leq t < +1500.0^{\circ}\text{C}$	1.2	1.2		
Extra TC	D (W3Re/W25Re)	$+1500.0^{\circ}\text{C} \leq t \leq +2315.0^{\circ}\text{C}$	1.8	ASTM E1751/E1751M	
		$+100.0^{\circ}\text{C} \leq t < +300.0^{\circ}\text{C}$	1.4		1.8
		$+300.0^{\circ}\text{C} \leq t < +1500.0^{\circ}\text{C}$	1.2		1.2
	G (W/W26Re)	$+1500.0^{\circ}\text{C} \leq t \leq +2315.0^{\circ}\text{C}$	1.8	ASTM E1751/E1751M	
		$+100.0^{\circ}\text{C} \leq t < +300.0^{\circ}\text{C}$	1.4		1.8
		$+300.0^{\circ}\text{C} \leq t < +1500.0^{\circ}\text{C}$	1.2		1.2
PLATINEL II	$0.0^{\circ}\text{C} \leq t < +100.0^{\circ}\text{C}$	0.6	ASTM E1751/E1751M		
	$+100.0^{\circ}\text{C} \leq t < +1000.0^{\circ}\text{C}$	0.8		1.8	
	$+1000.0^{\circ}\text{C} \leq t \leq +1395.0^{\circ}\text{C}$	1.0		2.2	

Errors of TC are not included
 Accuracy is specified at ambient temperature (Ta) of $\pm 23 \pm 5^{\circ}\text{C}$ using internal junction compensation.
 Temperature effect: 0.05%/°C is added for other ambient temperature (Ta < 18°C, Ta > 28°C)
 The display resolution for source / measure is 0.1°C

About formula of accuracy

The accuracy of source or measuring are defined by constant value or formula of linear expression.
 Example) Accuracy of type K at measuring point of 1000.0°C is $\pm(0.5 + (1000.0 - 500) \times 0.02\%)^{\circ}\text{C} = \pm 0.6^{\circ}\text{C}$

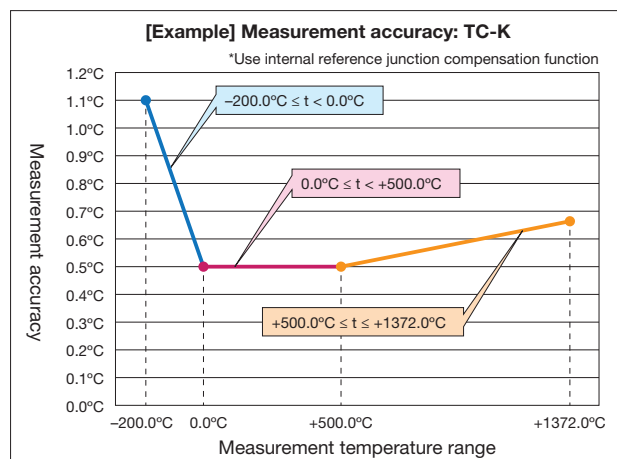

DC Voltage Source and Measurement

Range	Resolution	Source Measure range	Accuracy (1 year)		Notes
			Source	Measure	
90mV	1µV	-11.000 to ±99.999mV	0.015% of setting+10µV	0.015% of reading+10µV	Max. output current: 10mA

Accuracy is specified at ambient temperature (Ta) of $23 \pm 5^{\circ}\text{C}$
 Temperature effect : 0.005% of Range/°C is added for other ambient temperature (Ta < 18°C, Ta > 28°C)

■ Common source specification

- Output resistance: under 40mΩ
- Output response: under 300msec
- Max. load: C<0.1µF, L<10mH

Basic specification (Source/ Measure) CA330

RTD Source/Measure

t: Temperature of Source/Meas.

RTD	Coefficient	Accuracy (1 year)			Excitation current	Standard or Regulation	
		Source/Meas. Temp.	Source Accuracy [°C]	Meas. Accuracy [°C]			
Pt100	3851	-200.0°C ≤ t < 0.0°C	0.3	0.3	0.1-3mA	IEC60751 JIS C 1604	
		0.0°C ≤ t ≤ +800.0°C	0.3+tx0.033%	0.3+tx0.033%			
	3850	-200.0°C ≤ t < 0.0°C	0.3	0.3	0.1-3mA	JIS C 1604 1989 (Pt100)	
		0.0°C ≤ t ≤ +630.0°C	0.3+tx0.033%	0.3+tx0.033%			
	3916	-200.0°C ≤ t < 0.0°C	0.3	0.3	0.1-3mA	JIS C 1604 1989 (JPT100)	
		0.0°C ≤ t ≤ +510.0°C	0.3+tx0.033%	0.3+tx0.033%			
3926	-200.0°C ≤ t < 0.0°C	0.3	0.3	0.1-3mA	Minco Application Aid #18		
	0.0°C ≤ t ≤ +630.0°C	0.3+tx0.033%	0.3+tx0.033%				
Pt200	3851	-200.0°C ≤ t < 0.0°C	0.3	0.3	0.05-0.8mA	IEC60751	
Pt500	3851	-200.0°C ≤ t < 0.0°C	0.4	0.4	0.05-0.6mA	IEC60751	
		0.0°C ≤ t ≤ +630.0°C	0.4+tx0.033%	0.4+tx0.033%			
Pt1000	3851	-200.0°C ≤ t < 0.0°C	0.2	0.2	0.05-0.6mA	IEC60751	
		0.0°C ≤ t ≤ +630.0°C	0.2+tx0.033%	0.2+tx0.033%			
Cu10	427	-100.0°C ≤ t ≤ +260.0°C	1.5	1.5	0.1-3mA	Minco Application Aid #18	
Ni120	627	-80.0°C ≤ t ≤ +260.0°C	0.2	0.2	0.1-3mA	Minco Application Aid #18	
Extra RTD	Pt50	3851	-200.0°C ≤ t < 0.0°C	0.4	0.4	0.1-3mA	IEC60751
			0.0°C ≤ t ≤ +630.0°C	0.4+tx0.050%	0.4+tx0.050%		
	Pt50G	—	-200.0°C ≤ t < 0.0°C	0.4	0.4	0.1-3mA	GOST R 8.625-2006
			0.0°C ≤ t ≤ +800.0°C	0.4+tx0.050%	0.4+tx0.050%		
	Pt100G	—	-200.0°C ≤ t < 0.0°C	0.3	0.3	0.1-3mA	GOST R 8.625-2006
			0.0°C ≤ t ≤ +630.0°C	0.3+tx0.033%	0.3+tx0.033%		
	Cu50M	—	-180.0°C ≤ t < 0.0°C	0.4	0.4	0.1-3mA	GOST R 8.625-2006
			0.0°C ≤ t ≤ +200.0°C	0.4+tx0.050%	0.4+tx0.050%		
	Cu100M	—	-180.0°C ≤ t < 0.0°C	0.3	0.3	0.1-3mA	GOST R 8.625-2006
			0.0°C ≤ t ≤ +200.0°C	0.3+tx0.033%	0.3+tx0.033%		

Accuracy is specified at ambient temperature (Ta) of 23±5°C.

Temperature effect: 0.05°C/°C is added for other ambient temperature (Ta < 18°C, Ta > 28°C)

The display resolution for source / measure is 0.1°C

Above accuracy is specified for 4 wire measuring.

Accuracy for 3 wire measuring: 1.0°C to Cu10; 0.6°C to Pt50, Pt50G and Cu50M; 0.3°C to other RTD is each added, on condition the resistance of all cables are the same.

Accuracy for 2 wire measuring: Same with 3 wire measuring excluding resistance of cables.

About formula of accuracy

The accuracy of source or measuring are defined by constant value or formula of linear expression.

Example) Accuracy of Pt100(3851) at measuring point of 100.0°C is ±(0.3+100.0x0.033%)°C=±0.333°C

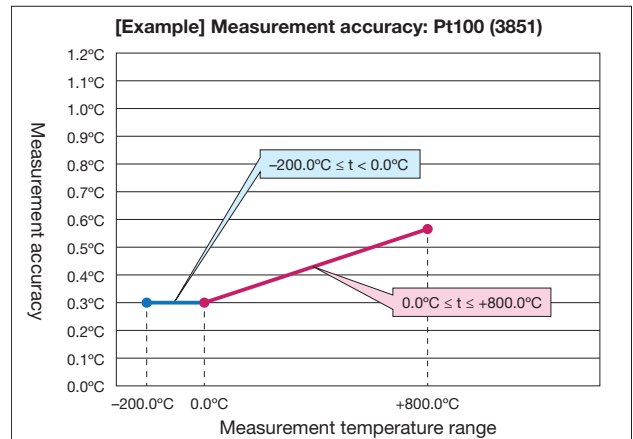

Resistance source and measure

Range	Resolution	Source and Meas. Range	Accuracy (1 year)		Note
			Source	Measurement	
500Ω	10mΩ	0.00 to 550.00Ω	0.025% of setting+0.1Ω	0.025% of reading+0.1Ω	Excitation current 0.1 to 3mA
3000Ω	100mΩ	0.0 to 3300.0Ω	0.025% of setting+0.5Ω	0.025% of reading+0.5Ω	Excitation current 0.05 to 0.6mA

Accuracy is specified at ambient temperature (Ta) of 23±5°C. Temperature effect: Add the accuracy of ±(0.005% of range) /°C for other ambient temperature (Ta < 18°C, Ta > 28°C) ..

Above accuracy is defined for 4-wire measuring.

Accuracy for 3 wire measuring: 0.05Ω to 500Ω range; 0.2Ω to 3000Ω range is added, on condition the resistance of all cables are the same.

Accuracy for 2 wire measuring: Same with 3 wire measuring on condition the resistance of cables are excluded.

Common measurement specification

- Excitation current: Method of voltage surge current measure (typical 0.78mA at 0Ω, 0.6mA at 500Ω, 0.27mA at 3000Ω)
- Disconnection detection: Detects when Hi terminal is open.
- Allowable resistance for measuring cables: under 10Ω

Common source specification

- Response time: Under 5msec (Excluding 3000Ω range, Pt500 and Pt1000)
- Max. load: C < 0.1μF, L < 10mH
- Sweep: Step (25%) / linear
- Step time: 15sec / 30sec / 45sec / 60sec



General Specification

Display	Segment LCD
Backlight	LED (Selection of "Constantly ON", "Constantly OFF" or "Auto off by approx. 2min")
Display refresh rate	Approx. 1sec.
Warm-up time	Approx. 5min.
Power supply	Four alkaline AA batteries, Dedicated AC Adapter (Sold separately)
Battery life	CA310: 50 hours (5V source, load over 10kOhm), 25 hours (20mA source, load under 5V) / CA320 : 55 hours / CA330 : 55 hours
Auto Power Off	Approx. 20min. (Disabled by setting)
Dimensions	Approx. 90 (W)×192 (H)×42 (D)
Weight	Approx. 440g
Standard	Safety: EN61010-1 / EN61010-2-030 EMC: EN61326-1 Class A Table 2. EN55011 Class A Group1
Operating temperature / humidity ranges	-10 to 55°C 20 to 80%RH (without condensation)
Storage temperature / humidity ranges	-20 to 60°C 90% RH or less (without condensation)
Accessories	CA310: Carrying case (B9108NK)/ Lead cables (a set of black and red lead wires for generation and measurement /98064) /four AA alkaline batteries/ Instruction manual CA320: Carrying case (B9108NK)/ Lead cables (a set of black and red lead wires for generation and measurement / 98040) /Binding post (Red Black 1 piece/ 99045) / four AA alkaline batteries/ Instruction manual CA330: Carrying case (B9108NK)/Lead cables(a set of 1 black and 3 red lead wires for generation and measurement/98035) /Binding post (Red Black 1 piece/99045) / Binding post (Red Red 1 piece / 99046) /four AA alkaline batteries/ Instruction manual

External Dimensions (CA300 series)

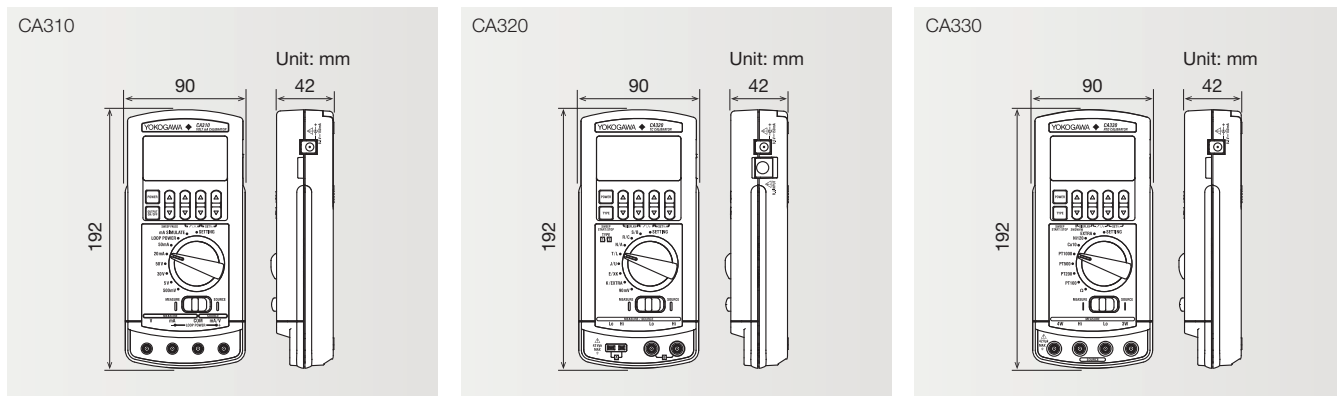

External Dimensions (Accessories)

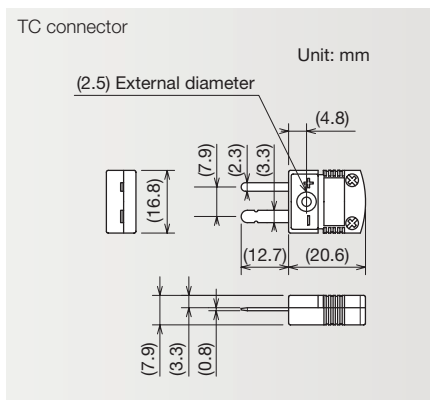
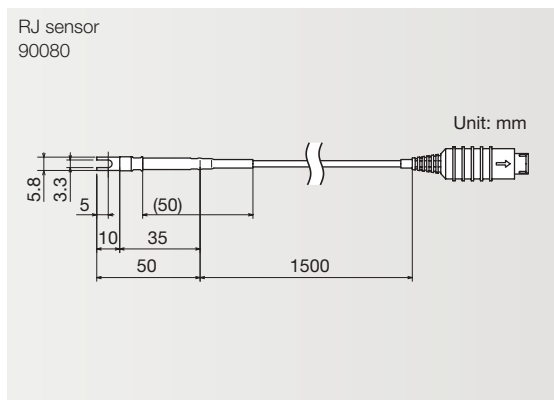

■ Model Name and Model Code

Main units (CA300 series)

Name	Model	Suffix Code	Description
Volt mA Calibrator	CA310		Voltage and Current Simulate Model
TC Calibrator	CA320		Thermocouple Simulate Model
RTD Calibrator	CA330		RTD Simulate Model
		/TE	Add °F setting procedure (for CA320, CA330)

Accessories Sold Separately **

Name	Model	Description
AC Adapter	94013	Input: AC 120V, 50/60Hz
AC Adapter	94016	Input: AC 220V to 240V, 50/60Hz
RJ Sensor ^{*2}	90080	for CA320: RJ (Reference Junction)
Grabber Clip ^{*3}	98026	for CA series: separate type (one set of Red and Black 2.0m)
Rubber Boots ^{*4}	93060	for protection of main unit
Strap	97040	for hanging main unit on wall with rubber boot
Accessory Case	B9108XA	for accessories
TC Mini Plug Set 1 ^{*5}	90040	K (Yellow) /E (Violet) /J (Black) /T (Blue) /R,S (Green) /B,U (White) /G (Red/Green) /D (Red/White) /C (Red) /N (Orange)
TC Mini Plug Set 2 ^{*5}	90045	K (Yellow) /E (Violet) /J (Black) /T (Blue)

*1: These accessories are not included with main unit when purchased

*2: RJ sensor is dedicated for CA320. It is unable to be used for CA71 and CA150

*3: It is impossible to be used with binding post (model no. 99045/99046)

*4: It is impossible to put in the carrying case with rubber boot (93060)

*5: TC mini plugs are dedicated for CA320. Other types of mini plugs are required to be prepared by customer.

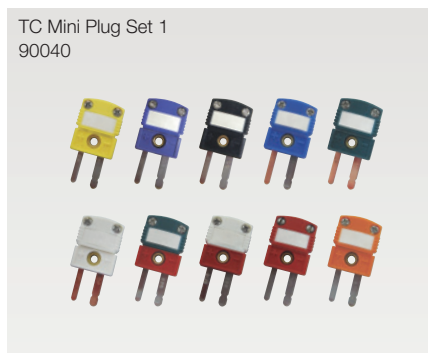
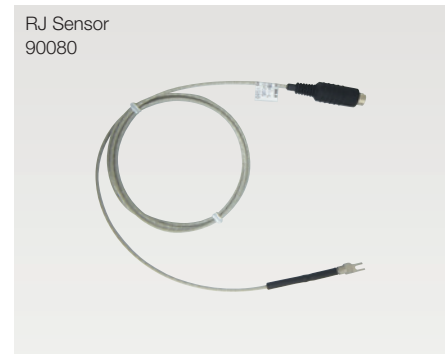



■ Model Name and Model Code

Accessories (included with main unit)*1

Name	Model	Description
Lead Cables*2	98064	for CA310, Alligator Clip Cable (Red Black 1 set/ 1.7m)
Lead Cables*3	98035	for CA330, Alligator Clip Cable (Red x 3pcs, Black x 1pce 1 set/ 1.7m)
Lead Cables*4	98040	for CA320, Alligator Clip Cable (Red Black 1 set/ 1.7m)
Binding Post (Red Black)*5	99045	1 short plate attached
Binding Post (Red Red)*6	99046	1 short plate attached
Carrying Case*7	B9108NK	for main unit and lead cables

*1: These accessories are included with main unit. Included types of accessories are different according to the type of main unit.

*2: Included with CA310 when purchased.

*3: Included with CA330 when purchased.

*4: Included with CA320 when purchased.

*5: Included with CA320/CA330 when purchased.

*6: Included with CA330 when purchased.

*7: It is impossible to put in main unit with rubber boots..

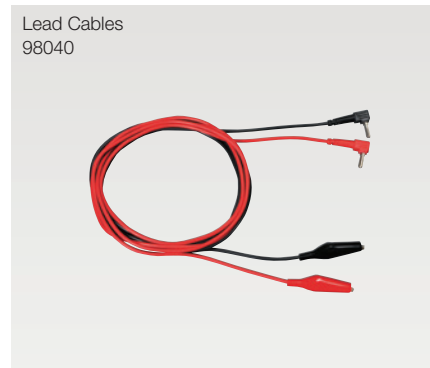
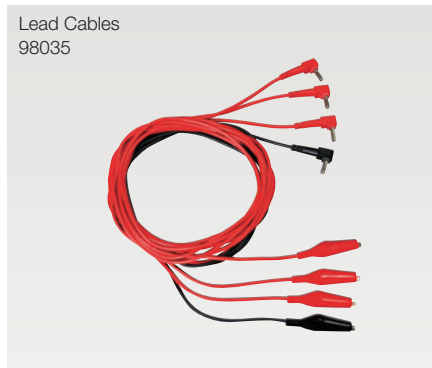

■ Related Products

PC-based field device management tool

- Multi-vendor, multi-protocol support BRAIN, FOUNDATION™, Fieldbus H1, HART®, PROFIBUS and ISA100.11a
- Automatic device data acquisition upon connection to a device or a segment (Segment Viewer)
- Easy acquisition and diagnosis of device status (Device Viewer)
- Categorization, sorting and filtering (History)
- Multi-parameter set-up (Parameter Manager)



FieldMate

Versatile Device Management Wizard

Handheld Terminal for BRAIN Communication

- Online monitoring and communication.
- Easy setup and alteration procedures in English prompting interactive sequences.
- Diagnostics/security with error messages. (Self-check function, Security code protection of setpoints, Low battery voltage alarm and Automatic power-off)
- Printer prints out tag numbers and other parameters on the spot.



**BRAIN Terminal
BT200**

New Standard for Field Calibration

- Achieves the highest accuracy in the portable class !
- Basic accuracy: Pressure (measurement) 0.01% rdg
Current/voltage (source/meas.) 0.015% rdg
- Achieves the highest resolution and widest range in portable class
- 0.001kPa (200.000kPa range)
- Calibration procedures of pressure transmitters and pressure switches are embedded.



**Pressure Calibrator
CA700**

Highly Accurate All-In-One Calibrator

- Dual display of source and measurement with an accuracy of 0.02%
- Multiple sources and measurements of DCV, DCmA, Ω, TC, RTD, Hz, and PULSE
- 24 V loop power supply and output signal measurement at the same time
- Current sink function to simulate a transmitter
- A variety of sweep functions selectable (Step, Linear, Program, and Sweep)
- Three power supply options available (AA batteries, AC adapter [sold separately], and NiMH batteries [sold separately])



**Handy Calibrator
CA150**

Safety DMM Equipped with a Loop Power Supply and 4-20 mA Output

- 24 V loop power supply and measures output signal at the same time
- Resistor (250Ω) for HART and BRAIN communication embedded and selectable.
- Transmitter simulation (current sink) function
- Step, Auto-step, and Linear sweep functions are selectable
- 6,000-count DMM function
- EN61010-1 CATIV600V and CATIII1000V safety design



**Process Multimeter
CA450**

Clamp-on Measurement of 4-20 mA Instrumentation Signals

- Process signal measurement with no need to disconnect a loop
- Accuracy 0.2% + 5 dgt and resolution 0.01 mA
- Simultaneous display of percentage (%) of the measured value and span
- LED backlight ideal for measuring in dark places
- Thick signal wire with a diameter of up to 6 mm can be clamped easily.



**Clamp-on Process Meter
CL420**

⚠ NOTICE

- Before using the product, read the instruction manual carefully to ensure proper and safe operation.

vigilantplant.®

SEE
CLEARLY

KNOW
IN ADVANCE

ACT
WITH AGILITY

The clear path to operational excellence

YOKOGAWA METERS & INSTRUMENTS CORPORATION

Global Sales Dept. /Phone: +81-422-52-6237 Facsimile: +81-422-52-6462 E-mail: tm@cs.jp.yokogawa.com

YOKOGAWA CORPORATION OF AMERICA

YOKOGAWA EUROPE B.V.

YOKOGAWA SHANGHAI TRADING CO., LTD.

YOKOGAWA ELECTRIC KOREA CO., LTD.

YOKOGAWA ENGINEERING ASIA PTE. LTD.

YOKOGAWA INDIA LTD.

YOKOGAWA ELECTRIC CIS LTD.

YOKOGAWA AMERICA DO SUL LTDA.

YOKOGAWA MIDDLE EAST & AFRICA B.S.C(c)

Phone: +31-88-4641000

Phone: +86-21-6239-6363

Phone: +82-2-2628-3810

Phone: +65-6241-9933

Phone: +91-80-4158-6396

Phone: +7-495-737-78-68

Phone: +55-11-5681-2400

Phone: +973-17-358100

Facsimile: +86-21-6880-4987

Facsimile: +82-2-2628-3899

Facsimile: +65-6241-9919

Facsimile: +91-80-2852-1442

Facsimile: +7-495-737-78-69

Facsimile: +973-17-336100

VigilantPlant is Yokogawa's automation concept for safe, reliable, and profitable plant operations. VigilantPlant aims to enable an ongoing state of Operational Excellence where plant personnel are watchful and attentive, well-informed, and ready to take actions that optimize plant and business performance.

Represented by:

tmi.yokogawa.com/

YMI-VP-BU-S-EN02

Subject to Change without notice.

All Rights Reserved. Copyright © 2015, Yokogawa Meters & Instruments Corporation
[Ed:02/b] Printed in Japan, 706(KP)

YOKOGAWA