



# Next generation in precision

## WT5000 Precision Power Analyzers



Precision Making

Bulletin WT5000-01EN

**As renewable energy, electric vehicles and energy efficient technologies gain wider adoption, the need for reliability in testing efficiency, performance and safety has never been greater.**

**Changing application needs and evolving international standards call for custom measurements and consistent accuracy. In the WT5000 Precision Power Analyzer, engineers have a versatile platform that not only delivers reliable measurements today but, is ready for the challenges of tomorrow.**

**With its unmatched accuracy and modular architecture, the WT5000 empowers engineers to innovate with precision, flexibility and confidence to quickly bring their products from concept to market.**

### **The WT5000 delivers:**

**Reliability** – With a guaranteed accuracy of  $\pm 0.03\%$ , harmonic comparisons up to the 500<sup>th</sup> order and custom computations, the WT5000 delivers multichannel measurements that you can trust.

**Versatility** – 7 slots for user swappable power elements and diverse options enable you to expand or reconfigure the WT5000 as your applications and their needs change. Additionally, the speed and torque from 4 separate motors are measurable.

**Simplicity** – With a full touchscreen experience, supported by hardware hotkeys and powerful software for remote measurements, connecting, configuring and measuring power has never been easier.





# Precision at your fingertips

## Multi-channel Measurements

Measure from up to 7 different power phases at 10 MS/s (18 bits). The high resolution, 10.1 inch WXGA display allows split screen viewing of up to 7 waveforms and can display up to 12 pages of diverse measurement parameters, making it ideal for efficiency tests of inverter driven motors, renewable energy technologies and traction applications like pumps, fans and electric vehicles. Measurements are also displayed in vector format or trending in time.

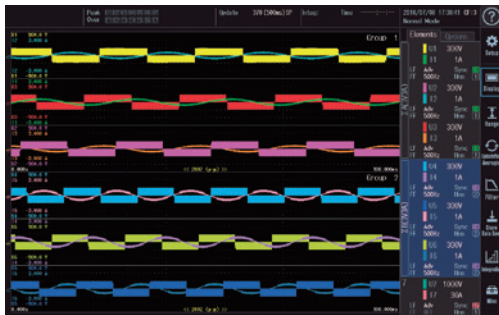

## Intuitive operation

Operable by touch and/or hardware hot-keys independently, the WT5000 offers a seamless and intuitive experience that makes connecting, configuring and measuring easier than ever before. The 10.1 inch WXGA touchscreen delivers excellent noise immunity even in high noise environments such as motors and inverters.



## Unmatched Accuracy

The WT5000 is the world's most accurate precision power analyzer with a basic power accuracy of  $\pm 0.03\%$ . Its accuracy specifications are guaranteed from 1% to 130% of the selected voltage and current ranges. With minimum influence of low power factor (0.02% of apparent power) the unit is also accurate at large phase shifts and frequencies.

- AC power accuracy: 0.01% of reading + 0.02% of range
- DC power accuracy: 0.02% of reading + 0.05% of range
- 10 MS/s 18 bit ADC

## Custom triggers and computations

Define and use event triggers and custom computations as per application needs. The event trigger function allows users to set limits to capture readings that fall within or outside a specific range of power, current or other parameters. Users can also define and use up to 20 different expressions for custom calculations. Data that meets the trigger conditions can be stored, printed, or saved to a USB memory device.

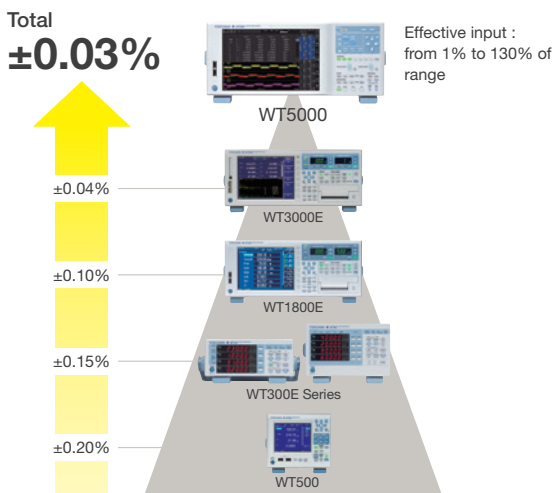

User Defined Functions				
	F1-F5	F6-F10	F11-F15	F16-F20
	Name	Expression	Unit	
F1	OFF	Avg. W	#(E1)/(TIME(E1)/3600)	W
F2	OFF	P-fact	P(E1)-P(E2)	W
F3	OFF	U-ripple	(UPK(E1)-UMK(E1))/2/DO(E1)*100	%
F4	OFF	I-ripple	(IPK(E1)-IMK(E1))/2/DO(E1)*100	%
F5	OFF	D-UmeR	DELTAURMS(SA)	V

User-defined function



## Advanced Filtering

In addition to low pass frequency filters and line filters, the WT5000 features advanced filtering capabilities that provides unprecedented control to analyze even the toughest of waveforms with precision.

- Synchronization source filter: Instead of synchronizing to zero crossings, users can select any specific point of the synchronization source signal.
- Enhanced frequency filter: Allows users to simultaneously measure fundamental and switching frequencies without influencing any other parameter.
- Digital Parallel Path filters: Supported by a high frequency anti-aliasing filter, two separate line filters for normal and harmonic measurements ensures accuracy without aliasing in wide band and harmonic measurements. Users can limit the number of harmonic orders to eliminate attenuation in low bandwidth measurements.









## Advanced Harmonic analysis

Evaluate and compare input and output harmonics of inverters, motors or power conditioners up to the 500<sup>th</sup> order. The WT5000 allows users to not only measure harmonics and power simultaneously but also offers side by side comparison of harmonics from two different input sources.

The effects of noise and aliasing are minimized by antialiasing and line filters with Digital Parallel Path technology allowing simultaneous power analysis of wide band and narrow band components.



## Precision Measurements for your application

Field	Application purpose	Measurement Parameters
Electric Vehicles 	Powertrain Efficiency Motor Evaluation Battery charging/discharging	DC & AC power parameters, torque, speed electrical, mechanical and overall efficiency, power consumption, and loss
Renewable Energy 	Power conditioner evaluation Maximum Power Point Tracking Harmonic analysis	Boost converter and inverter efficiency Battery voltage, motor rotation pulse Harmonic Distortion Factor, Ripple factor
Industrial Robotics 	Power consumption analysis, Operation and Standby mode testing Transient Power analysis	Efficiency, duty cycle. Sensor receiving wave, receiving pulse
Home & office Appliances 	Standby Power testing Lighting – Switching and PWM modulation	AC power, voltage, current at standby and operation modes. Average Active power
Transformer Testing 	loss measurement and short circuit testing	AC power, Low power factor
Healthcare & Medical equipment 	Power consumption measurement to guarantee quality	Low and high frequency power measurement

# Customize/configure your test bench

## Evaluate motors, drives and inverters

Measure more than just electrical parameters. The motor evaluation function enables measurements of rotational speed and direction, synchronous speed, slip, torque, mechanical power, electrical angle and motor efficiency from an analog or pulse output of torque sensors or pulse outputs of rotation sensors.

Up to 2 motors can be measured per WT5000 when the determination of the rotation direction and the electrical angle is needed. However, a simple setting in the motor configuration menu, allows a single WT5000 to take synchronous measurements from up to 4 torque and rotation sensors enabling users to determine the overall efficiency from 4 wheel driven vehicles.

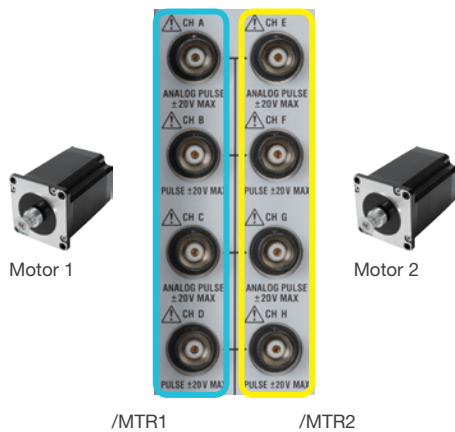

A single WT5000 configured for simultaneous, synchronized measurements from 2 motors to determine torque, rotation speed, direction and electrical angles of A/B/C and Z phases

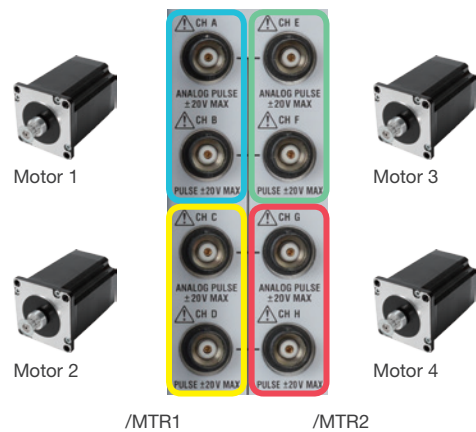

A single WT5000 configured for simultaneous synchronized measurements from 4 torque and rotation sensors to determine overall efficiency of 4 motors

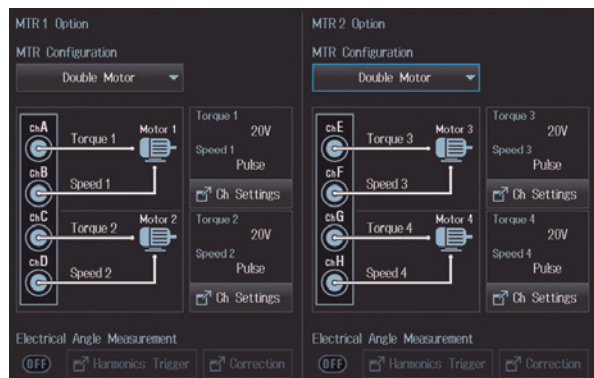
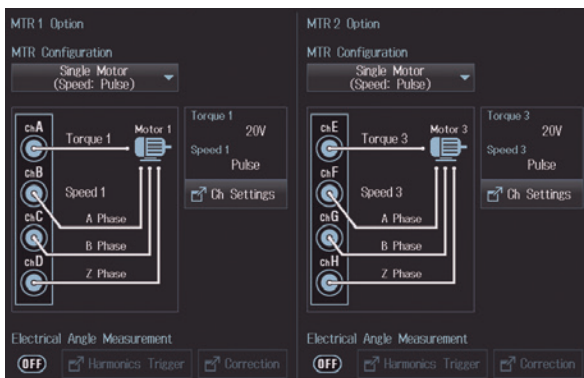

Use /MTR1 and /MTR2 options together to measure up to 4 motors simultaneously.

## Up to 32 GB of internal memory

The WT5000 offers up to 32 GB of internal storage memory that can be used to store and recall various custom configurations and test setups. It can also be used to log large amounts of measurement data over long periods of time, behaving just like a logger. This large non-volatile memory makes it easy to store data without preparing any external media. Save Waveform/Numeric/Screen Copy data or Setting Information.

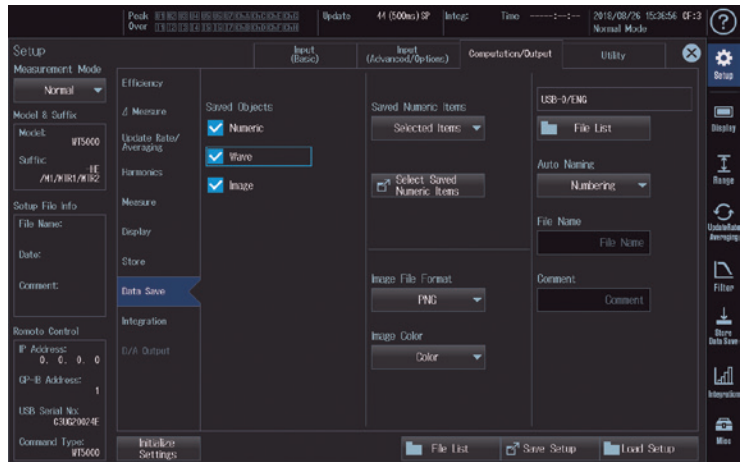
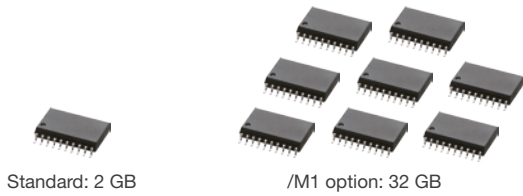

## Communications

Not only does the WT5000 support GP-IB, USB and Ethernet communications but is also backward compatible with communication commands of previous models.

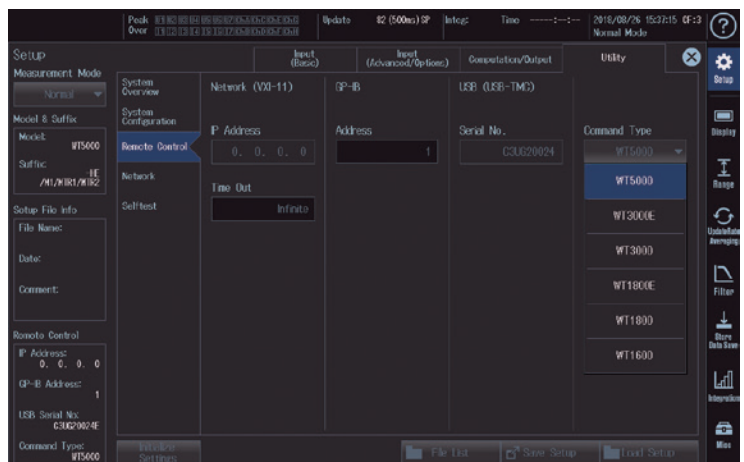

## Extend your measurements with Master/Slave synchronization

When synchronizing 4 WT5000s with one master unit and 3 slave units, you have access to 28 input elements for electrical power measurements and up to 16 motor evaluation functions. The WTViewerE software will support this performance.

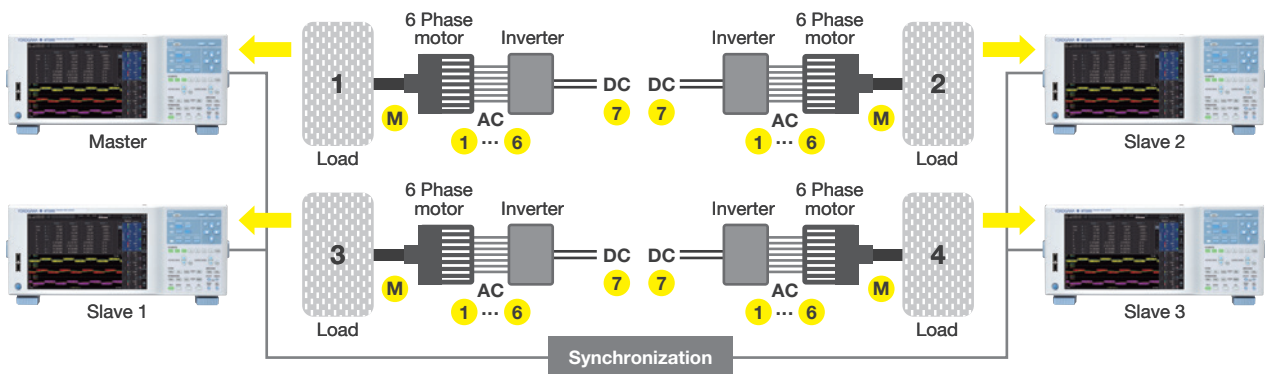

# Precision made easy



## 1 Peripheral Device Connection

Two USB ports for connection to a storage, keyboard, mouse etc.

## 2 10.1 inch WXGA Touch Screen

A 10.1 inch resistive touch screen delivers excellent noise immunity performance even in environments with high electrical noise such as motors and inverters.

## 3 Display Format setting

Comprehensive range of display functions for power analysis, including numeric/waveform/vector/bar.

## 4 Input element and range setting keys

Set the voltage and current ranges on up to 7 input elements.

## 5 Store and Integration function key

Store and Integration function setting and execution key

## 6 Communication functions

USB (3.0), Ethernet (VXI-11) and GP-IB

## 7 Connectors for multi-unit synchronizations

One master and three slaves, a total of 4 units can be connected.

## 8 RGB output

Video signal output for 1280 × 800 dots WXGA high resolution RGB display

## 9 30 A input element

High accuracy element, from 0.5 to 30 A direct current and 1.5 to 1000 V direct voltage input. Users can install, remove or swap these input elements themselves.

## 10 5 A input element

High accuracy element, from 5 mA to 5 A direct current and 1.5 to 1000 V direct voltage input. Users can install, remove or swap these input elements themselves.

## 11 Motor Evaluation function 1 (optional)

Select Torque (Pulse/Analog) and A/B/Z (Pulses) inputs or two sets of Torque (Pulse/Analog) and A (Pulse) inputs

## 12 Motor evaluation function 2 (optional)

Select Torque (Pulse/Analog) and A/B/Z (Pulses) inputs or two sets of Torque (Pulse/Analog) and A (Pulse) inputs

\* /MTR2 option requires installation of /MTR1 option.





9



10



The direct input terminal adopted male type large safety terminals preventing any mistakes as voltage input terminals. A dedicated safety terminal adapter set is attached as standard.

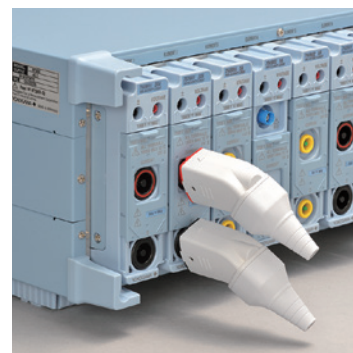

# Next generation in precision

Through our work with engineers in the areas of R&D, Production, QA and Field Testing, Yokogawa recognizes the importance of reliable and precise measurements for making critical decisions in product development and compliance. For more than a 100 years, we have been pushing the limits of measurement accuracy and integrity with every generation of our measurement technologies.

With the WT5000, Yokogawa ushers in a new era of precision power measurements that provides engineers with the accuracy and the confidence to keep up with evolving international standards as well as the flexibility to adapt to ever changing application needs. Packing the very best in isolation, noise immunity, current sensing and filtering in a modular architecture, the WT5000 is an extensible measurement platform that unlocks precision power analysis for electromechanical systems in electric vehicles, renewable energy, home and office appliances and industrial equipment.

**Precision current sensing** – The coaxial construction of current shunts in the swappable 30 A input element ensures low resistance, low inductance, low impact on phase shift and minimizes heat dissipation. Heat flow pathways are optimized in the shunts and across the instrument to ensure even distribution and minimum effect on resistance.

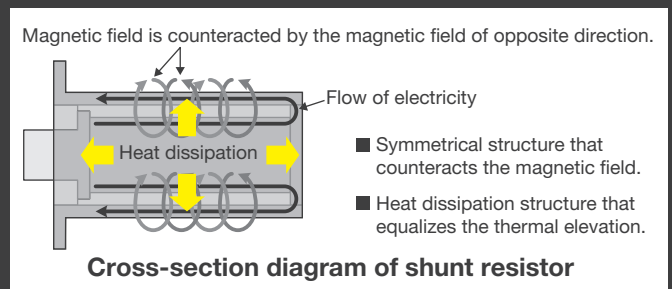

**Advanced filtering** – Whether it is for custom synchronization of measurements, smoothing of signal fluctuations or simultaneous wideband and harmonic power analysis, the advanced filtering options of the WT5000 puts the user in control of his measurements without compromising on accuracy.

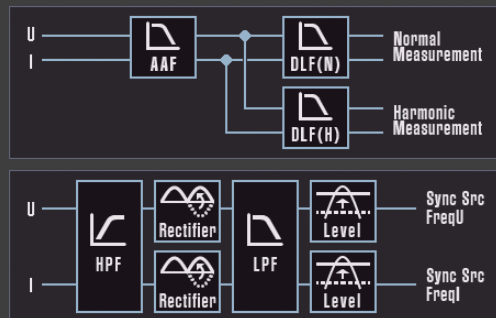

**Noise and isolation** – Special shielding and optical transmission protects against noise and crosstalk. Yokogawa's isoPRO™ technology ensures fast data transmission (Max. 10 MS/s) and industry leading isolation to the input elements and is designed particularly for energy-saving applications, at high voltage, large currents and high frequency. Noise flow routes are optimized for minimum effect on the measurement circuitry.

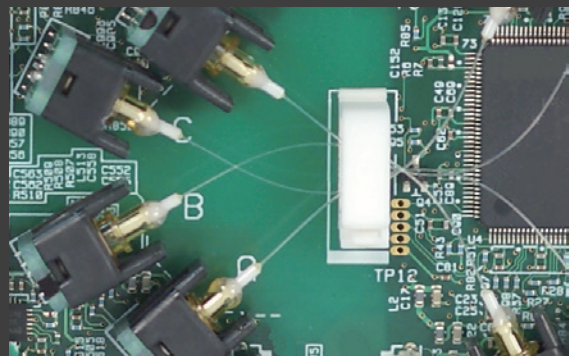



# Applications

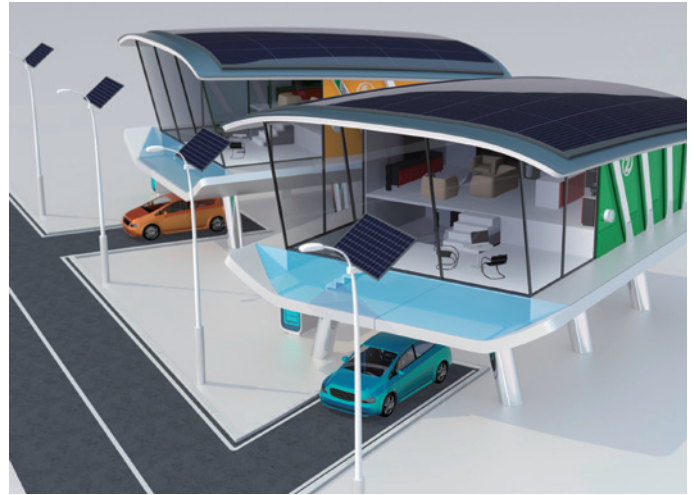

# Electric Vehicle development

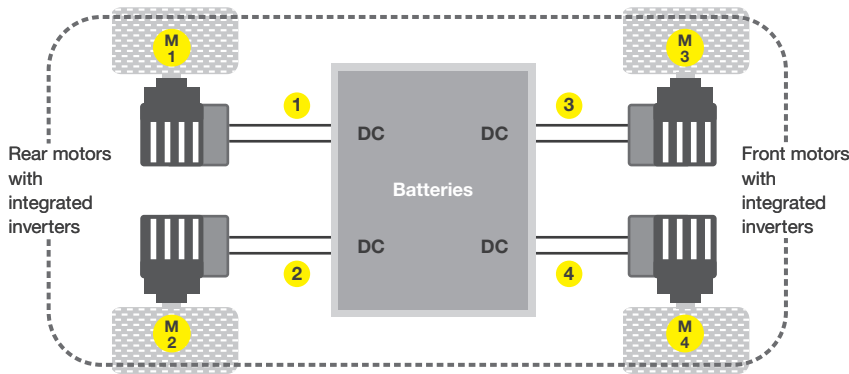

**Case1:** Modern drive systems with integrated inverters do not allow access to the AC signals. Here one of the main measurement tasks is to measure the overall drive train efficiency from DC to mechanical power. The example shows 4 DC measurements (1 to 4) with the corresponding 4 mechanical power measurements (M1 to M4)

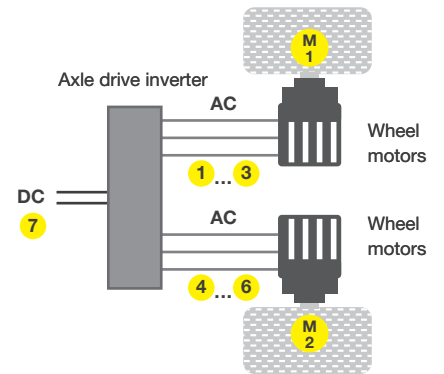

**Case2:** Example of an axle power efficiency measurement from DC (7) to dual 3-phase AC (1 to 3 and 4 to 6) plus dual mechanical power (M1 and M2)

## Overview

Between 16 to 18% of the total charge of an electric car is consumed by electric drive system losses. Electric and hybrid car manufacturers therefore need to accurately evaluate motor and inverter control in order to achieve higher precision and greater efficiency. Additionally, the accurate analysis of inverter waveforms without interference from switching noise is a key part of evaluating the motor drive circuit.

### Key requirements

- Multi-phase measurements from battery, inverter and motor
- Evaluation of motor characteristics such as torque, rotation speed and direction, slip and electrical angle
- Battery charging/discharging characteristics
- Harmonic analysis of inverter signals at various rotation speeds

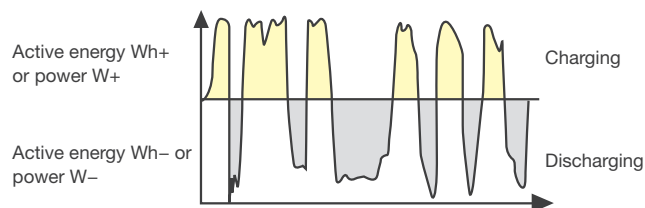

**Battery charging and discharging characteristics**

## The WT5000 advantage

With high accuracy, multi-channel power measurements, evaluation of up to 4 motors and harmonic comparison capabilities, the WT5000 helps automotive engineers improve conversion efficiency, shorten charging times and improve driving range.

### Guaranteed accuracy in multichannel measurements

It enables simultaneous measurements of voltage, current, power, torque, rotation speed, electrical angle and mechanical power.

### Motor evaluation and mechatronic efficiency

Measure rotation speed, torque, and output (mechanical power) of motors from analog/pulse inputs of rotation or torque sensors. A single WT5000 can be configured for synchronized measurements from up to 4 motors simultaneously.

### Battery charging & discharging characteristics

Integration of Instantaneous positive and negative values of energy allows the evaluation of battery charging and discharging characteristics.

### Harmonics Analysis & comparisons

With the ability to measure harmonics up to the 500<sup>th</sup> order even at low rotation speeds, the WT5000 supports harmonic analysis without the need for an external sampling clock.



# Renewable energy development

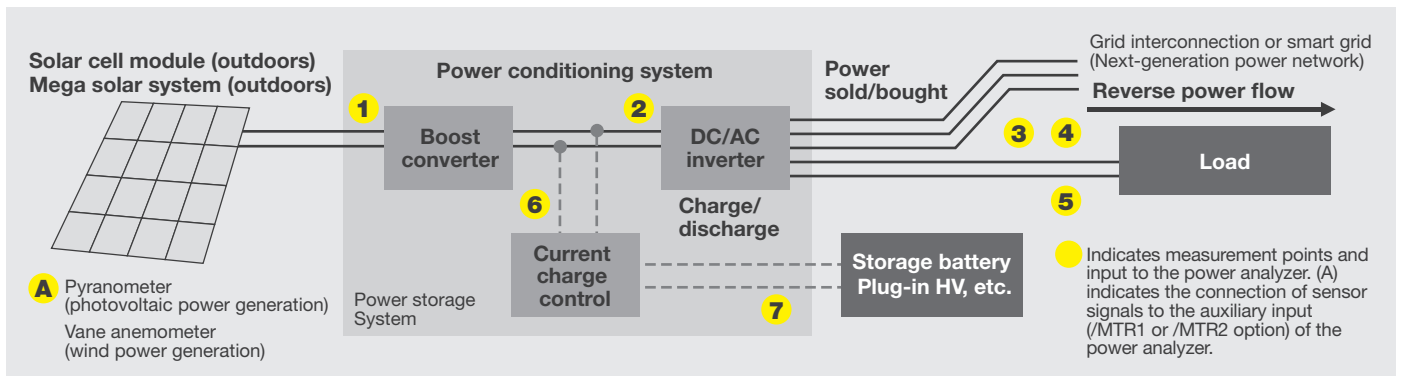

## Overview

Energy generated by photovoltaic cell modules and wind turbines is converted from DC to AC by a power conditioner. Minimizing losses in these conversions is key to improve the efficiency of the overall energy system.

### Key requirements

- Multi-phase measurements from boost converter, inverter and storage battery
- Evaluation of maximum power and instantaneous peak values
- Energy bought and sold in grid
- Battery charging/discharging characteristics
- Harmonic analysis of inverter signals at various generator speeds

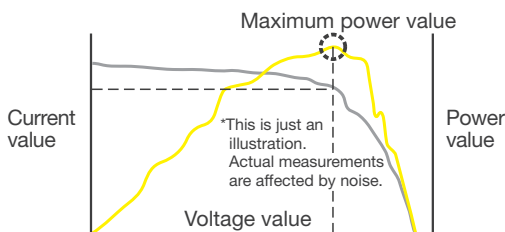

Typical voltage, current, and power measurements in MPPT control

## The WT5000 advantage

WT5000 helps engineers working in the development of renewable energy solutions, to improve conversion efficiency by offering precision insights in charging, discharging, storage and overall efficiency.

### Multi-channel Power measurements

Evaluate Power conditioner efficiency with simultaneous measurements from the inputs and outputs of boost converter, inverter, and storage battery. With measurement capabilities from up to 7 input elements the WT5000 is ideal for voltage, current, power, and frequency (for AC) before and after each converter, as well as converter efficiency and charging efficiency.

### Instantaneous peak power

In photovoltaic power generation, an Maximum Power Point Tracker (MPPT) controller varies the voltage to maximize energy harvested from the solar panel. The WT5000 is capable of measuring not only the voltage, current, and power but also the voltage, current, and power peak values plus (+) and minus (-) sides, respectively

### Energy Bought/Sold and Charged/Discharged

The WT5000E provides a current integration (q), apparent power integration (WS), reactive power integration (WQ), as well as effective power integration capable of integration in the power sold/bought and charge/discharge modes.

### Harmonics Analysis & comparisons

Voltage fluctuations and harmonics flow into the power systems due to reverse power flow. The harmonic measurement function enables measurement of harmonic components to compute and display total harmonic distortion (THD) and harmonic distortion factor.

# Inverter/motor drives

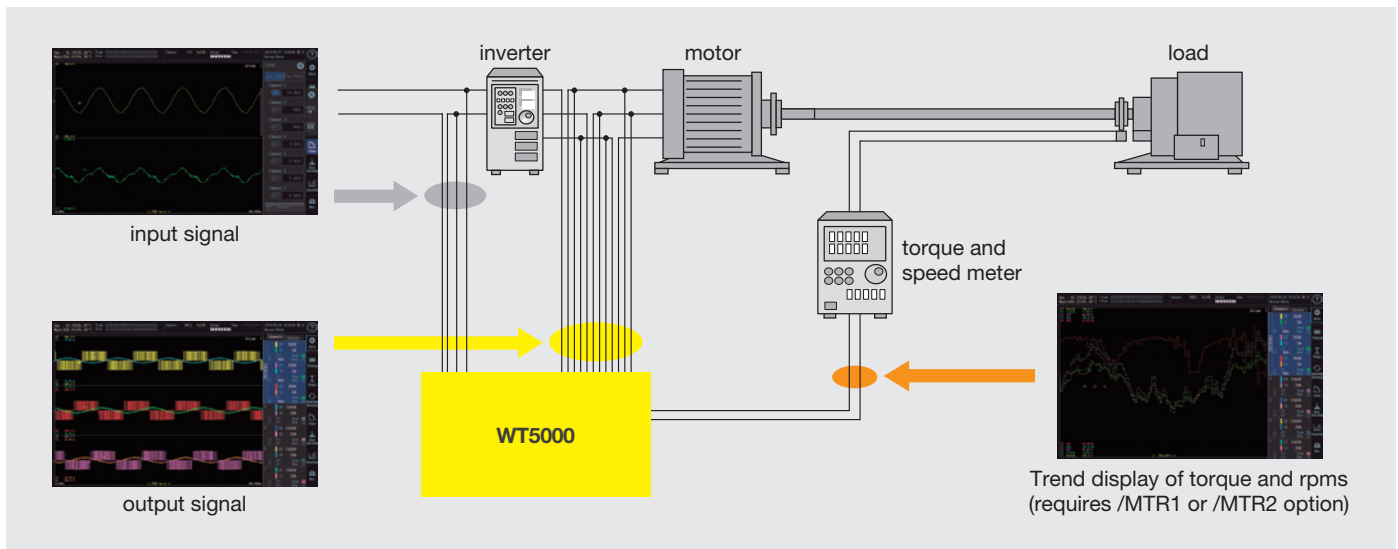

## Overview

Motor drive technology has become more complex in recent years, pure sine-wave PWM is less common, and cases where the mean voltage differs greatly from the fundamental voltage waveform, are more frequent.

### Key requirements

- Multi-phase measurements from battery, inverter and motor
- Evaluation of motor characteristics such as torque, rotation speed and direction, slip and electrical angle
- Harmonic analysis of inverter signals at various rotational speeds

## The WT5000 advantage

With high accuracy, multi-channel power measurements, motor evaluation and harmonic comparison capabilities, the WT5000 helps engineers in motor and drive development to improve power consumption and conversion efficiency in inverter/motor drive systems.

### Guaranteed accuracy across a wide range

The WT5000 guarantees a basic power accuracy of  $\pm 0.03\%$ , between 1% to 130% of the selected voltage and current measurement ranges, at 50/60 Hz. Simultaneous measurements from the inputs and outputs of boost converter, inverter, and storage battery

### Inverter and motor efficiency

In addition to computing power conversion efficiency of inverter and motor (up to 7 power inputs), the WT5000, also allows the measurement of rotational speed, torque, and output (mechanical power) from the analog/pulse inputs of rotation or torque sensor.

### Harmonics Analysis & comparisons

With the ability to measure harmonics up to the 500<sup>th</sup> order even at low rotation speeds the WT5000 supports harmonic analysis without the need of an external sampling clock.

# Magnetic characteristics Testing

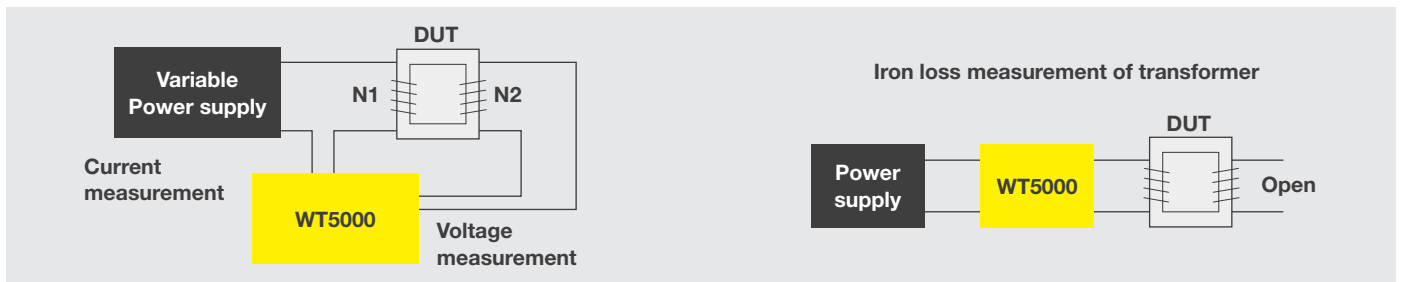

## Overview

In transformer or reactor development, the WT5000 can be used to evaluate magnetic material characteristics using Epstein frame system.

### Key requirements include

- High precision measurements of primary coil current and secondary coil voltage is needed.
- High accuracy in low power factor is needed.
- The magnetic flux density  $B$  and AC magnetic field  $H$  are key parameters to calculate iron loss.

## The WT5000 advantage

### Highest voltage and current accuracy

WT5000 provides highest power accuracy:  
0.01% of reading + 0.02% of range (50/60 Hz)

### High accuracy at low power factor

Effect of Power Factor of WT5000:  
0.02% of  $S$  (0.5 A or more)  
0.07% of  $S$  (200 mA or less)

# Power calibration

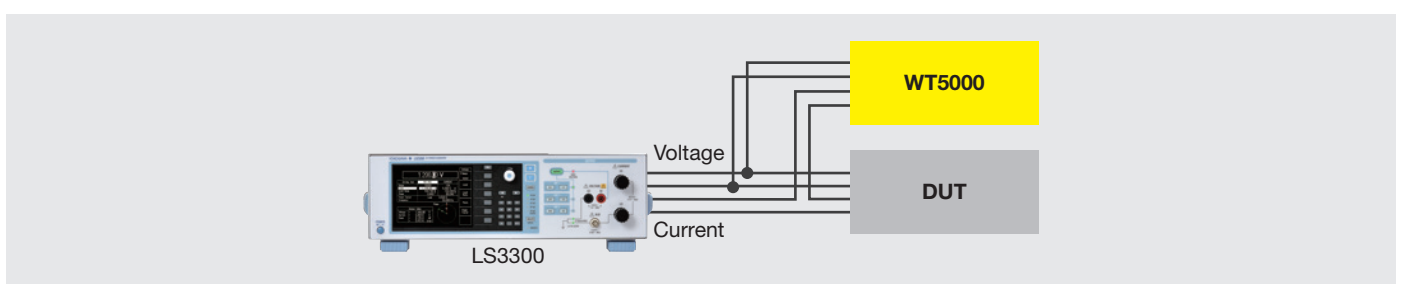

## Overview

For customers who use a large number of power meters, WT5000 can be used as a reference standard for periodic in-house calibration of power measurement instruments, such as the WT300E series and WT500.

### Key requirements include:

- Sufficient power accuracy is needed for power measurement instruments.
- Power factor is adjustable, and the accuracy in low power factor is guaranteed.

## The WT5000 advantage

### Highest power accuracy

WT5000 provides highest power accuracy:  
0.01% of reading + 0.02% of range (50/60 Hz)

### High accuracy at low power factor

Effect of Power Factor of WT5000:  
0.02% of  $S$  (0.5 A or more)  
0.07% of  $S$  (200 mA or less)

# Specification of 760901, 30 A high accuracy element and 760902, 5 A high accuracy element

Element style and the installation	
Element	Plug-in unit type
Number of slot	7
Installed style	Modular style dedicated to WT5000 (main body)
Mixed installation	Possible for both 30 A and 5 A element together
Installation with empty slot	Possible, however, user cannot make use of elements after empty slot.
Live installation or pulling out	Impossible

Input	
<b>Input terminal type</b>	
Voltage	Plug-in terminal (safety terminal)
Current	Direct input: Plug-in terminal (safety terminal) External Current Sensor input: Isolated BNC
<b>Input format</b>	
Voltage	Floating input, resistive voltage divider
Current	Floating input, through shunt

Measurement range	
Voltage	1.5/3/6/10/15/30/60/100/150/300/600/1000 V (Crest factor CF3) 0.75/1.5/3/5/7.5/15/30/50/75/150/300/500 V (Crest factor CF6/CF6A)
Current	Direct input 760901 500 mA, 1 A, 2 A, 5 A, 10 A, 20 A, 30 A (Crest factor CF3) 250 mA, 500 mA, 1 A, 2.5 A, 5 A, 10 A, 15 A (Crest factor CF6/CF6A)
	760902 5 mA, 10 mA, 20 mA, 50 mA, 100 mA, 200 mA, 500 A, 1 A, 2 A, 5 A (Crest factor CF3) 2.5 mA, 5 mA, 10 mA, 25 mA, 50 mA, 100 mA, 200 m, 500 mA, 2.5 A (Crest factor CF6/CF6A)
External Current Sensor input	
	50 mV, 100 mV, 200 mV, 500 mV, 1 V, 2 V, 5 V, 10 V (Crest factor CF3) 25 mV, 50 nV, 100 mV, 250 mV, 500 mV, 1 V, 2.5 V, 5 V (Crest factor CF6/CF6A)

Instrument loss	
Voltage	Input resistance 10 MΩ ±1% (Approx. 12 pF)
Current	Direct input 760901 Input resistance: 6.5 mΩ ±10% + Approx. 0.3 μH 760902 Input resistance: 0.5 Ω ±10% + Approx. 0.3 μH input inductance: 0.11 Ω ±10% + Approx. 0.3 μH
External Current Sensor input	
	Input resistance 1 MΩ ±1% (Approx. 50 pF)

Instantaneous maximum allowable input (1 s or less)	
Voltage	Peak voltage of 2.5 kV or RMS of 1.5 kV whichever is lower
Current	Direct input 760901 Peak current of 150 A or RMS of 50 A whichever is lower 760902 Peak current of 30 A or RMS of 15 A whichever is lower
External Current Sensor input	
	Peak voltage is less than 10 times of the range or 25 V whichever is lower

Continuous maximum allowable input	
Voltage	Peak voltage of 1.6 kV or RMS of 1.5 kV whichever is lower If the frequency of the input voltage exceeds 100 kHz, (1200 – f) Vrms or less, the "f" indicates the frequency of the input voltage and the unit is kHz
Current	Direct input 760901 Peak current of 90 A or RMS of 33 A whichever is lower 760902 Peak current of 10 A or RMS of 7 A whichever is lower
External Current Sensor input	
	Peak voltage is less than 5 times the range or 25 V whichever is lower

Voltage Continuous maximum voltage to earth (DC to 50/60 Hz)	
Voltage input terminals	(DC to 50/60 Hz) 1000 V CAT II
Current input terminals	(DC to 50/60 Hz) 1000 V CAT II
External Current Sensor input connector	
	(DC to 50/60 Hz) 1000 V CAT II

Influence from common mode voltage	
Apply 1000 Vrms for input terminal and case with the voltage input terminals shorted, the current input terminals open, and the external current sensor input terminals shorted.	
50/60 Hz: ±0.01% of range or less	
Reference value: Up to 200 kHz:	
Voltage	±((Maximum rated range)/(rated range) × 0.001 × f% of range) or less
Current	Direct input ±((Maximum rated range)/(rated range) × 0.001 × f% of range) or less
External Current Sensor input	
	±((Maximum rated range)/(rated range) × 0.001 × f% of range) or less However, 0.01% or more, unit of f is kHz
The maximum rated range which is equation is Voltage 1000 V, Current direct input 30 A for 760901 5 A for 760902, External Current Sensor input 10 V.	

A/D converter	
Simultaneous voltage and current input conversion	
Resolution	18 bit
Conversion speed (Sampling period):	Maximum 100 ns

Lower frequency limit of measurement					
Sync source period average method					
Data update rate	50 ms	100 ms	200 ms	500 ms	
Measurement lower limit frequency	45 Hz	20 Hz	10 Hz	5 Hz	
Digital filtering average method					
Data update rate	1 s	2 s	5 s	10 s	20 s
Measurement lower limit frequency	2 Hz	1 Hz	0.5 Hz	0.2 Hz	0.1 Hz

Accuracy (six-month)	
One-year Accuracy	
Multiply the reading accuracy of the six-month accuracy by a factor of 1.5.	
Conditions	Temperature: 23±5°C. Humidity: 30 to 75% RH. Input waveform: Sine wave. λ (Power factor): 1. Common mode voltage: 0 V. Crest factor: CF3 Line filter: OFF Frequency filter: On (1 kHz or less when average method is Sync source period average) Signal level of Synch source: Same as frequency measurement After warm-up time (30 minutes) After Zero calibration of measurement range change under wiring with calibrators Unit of f of below formulas is kHz Input range AC: 10 to 110% of range DC: 1 to 110% of range

Voltage	
DC	±(0.02% of reading + 0.05% of range)
0.1 Hz ≤ f < 10 Hz	±(0.03% of reading + 0.05% of range)
10 Hz ≤ f < 45 Hz	±(0.03% of reading + 0.05% of range)
45 Hz ≤ f ≤ 66 Hz	±(0.01% of reading + 0.02% of range)
66 Hz < f ≤ 1 kHz	±(0.03% of reading + 0.04 of range)
1 kHz < f ≤ 10 kHz	±(0.1% of reading + 0.05% of range) Add 0.015% × f of reading (lower than 10 V range )
10 kHz < f ≤ 50 kHz	±(0.3% of reading + 0.1% of range)
50 kHz < f ≤ 100 kHz	±(0.6% of reading + 0.2% of range)
100 kHz < f ≤ 500 kHz	±((0.006 × f)% of reading + 0.5% of range)
500 kHz < f ≤ 1 MHz	±((0.022 × f – 8)% of reading + 1% of range)
Bandwidth	DC to 10 MHz (Typical, –3 dB)

Current	
DC	±(0.02% of reading + 0.05% of range)
0.1 Hz ≤ f < 10 Hz	±(0.03% of reading + 0.05% of range)
10 Hz ≤ f < 45 Hz	±(0.03% of reading + 0.05% of range)
45 Hz ≤ f ≤ 66 Hz	±(0.01% of reading + 0.02% of range) ±0.5 μA* *only direct input of 760902
66 Hz < f ≤ 1 kHz	±(0.03% of reading + 0.04 of range)
1 kHz < f ≤ 10 kHz	±(0.1% of reading + 0.05% of range)
10 kHz < f ≤ 50 kHz	±(0.3% of reading + 0.1% of range)
50 kHz < f ≤ 100 kHz	±(0.6% of reading + 0.2% of range)
100 kHz < f ≤ 200 kHz	±((0.00725 × f – 0.125)% of reading + 0.5% of range)
200 kHz < f ≤ 500 kHz	±((0.00725 × f – 0.125)% of reading + 0.5% of range)
500 kHz < f ≤ 1 MHz	±((0.022 × f – 8)% of reading + 1% of range)
Bandwidth	Direct input: DC to 5 MHz (Typical, –3 dB) External Current Sensor input: DC to 5 MHz (Typical, –3 dB)

Power (PF=1)	
DC	±(0.02% of reading + 0.05% of range)
0.1 Hz ≤ f < 10 Hz	±(0.08% of reading + 0.1% of range)
10 Hz ≤ f < 30 Hz	±(0.08% of reading + 0.1% of range)
30 Hz ≤ f < 45 Hz	±(0.05% of reading + 0.05% of range)
45 Hz ≤ f ≤ 66 Hz	±(0.01% of reading + 0.02% of range)
66 Hz < f ≤ 1 kHz	±(0.05% of reading + 0.05% of range)
1 kHz < f ≤ 10 kHz	±(0.15% of reading + 0.1% of range) Add 0.01% × f of reading (lower than 10 V range)
10 kHz < f ≤ 50 kHz	±(0.3% of reading + 0.2% of range)
50 kHz < f ≤ 100 kHz	±(0.7% of reading + 0.3% of range)
100 kHz < f ≤ 200 kHz	±((0.008 × f)% of reading + 1% of range)
200 kHz < f ≤ 500 kHz	±((0.008 × f)% of reading + 1% of range)
500 kHz < f ≤ 1 MHz	±((0.048 × f – 20)% of reading + 1% of range)

- Range of guaranteed accuracy by frequency, voltage, and current  
All accuracies between 0.1 Hz and 10 Hz are reference values.  
If the voltage exceeds 750 V at 30 kHz to 100 kHz, the voltage and power values are reference values.  
If the current exceeds 20 A at DC, 10 Hz to 45 Hz, or 400 Hz to 100 kHz, the current and power accuracies are reference values.
- Influence of data update rate  
Add the following value to the accuracy with Sync source period method  
50 ms: ±0.03% of reading  
100 ms: ±0.02% of reading



- Accuracy for crest factor CF6/CF6A  
Same as the range accuracy of crest factor CF3 for twice the range.
- Influence of Power Factor  $\lambda$   
When  $\lambda = 0$   
±Apparent power reading × 0.02% of the range, 45 Hz to 66 Hz  
For frequencies other than the above (Reference values):  
±Apparent power reading × (0.02 + 0.05 × f%)  
When  $0 < \lambda < 1$   
±Power reading × [(power reading error %) + (power range error %) × (power range / apparent power reading) + (tan  $\phi$  × influence % when  $\lambda = 0$ )]  
However,  $\phi$  is the phase angle between the voltage and current.

**Temperature coefficient**  
±0.01% of reading/°C at 5 to 18°C or 28 to 40°C

**Effective input range**  
Udc and Idc: 0 to ±130% of the measurement range except for 1000 V range  
1000 V range: 0 to ±150%  
Urms and Irms: 1 to 130% of the measurement range for crest factor CF3  
Urms and Irms: 2 to 130% of the measurement range for crest factor CF6/CF6A  
Umn and Imn: 10 to 130% of the measurement range  
Urm and Irm: 10 to 130% of the measurement range  
Regarding power, 0 to ±130% for DC measurement, up to 130% of the power range when the voltage with under current range is 1 to 130% for AC measurement.

\*In case of measured value from 110% to 130% of range, Multiply the reading error by a factor of 1.5.

When input voltage is over 600 V, add 0.02% of reading  
However, for Sync source period method, the synchronization source level shall meet the input signal level of frequency measurement.

**Influence of Line filter**  
Bessel 5 orders LPF, fc = 1 MHz:  
Voltage/Current Up to 100 kHz: Add ±(20 × f/fc) % of reading  
Power Up to 100 kHz: Add ± (40 × f/fc) % of reading  
Refer to WT5000 (main body) line filter, if lower than 100 kHz of fc

**Frequency measurement**  
Measurement range

Update rate	Measurement range
50 ms	45 Hz ≤ f ≤ 2 MHz
100 ms	20 Hz ≤ f ≤ 2 MHz
200 ms	10 Hz ≤ f ≤ 2 MHz
500 ms	5 Hz ≤ f ≤ 2 MHz
1 s	2 Hz ≤ f ≤ 2 MHz
2 s	1 Hz ≤ f ≤ 2 MHz
5 s	0.5 Hz ≤ f ≤ 2 MHz
10 s	0.2 Hz ≤ f ≤ 2 MHz
20 s	0.1 Hz ≤ f ≤ 2 MHz

Accuracy ±(0.06% of reading + 0.1 mHz)

**Conditions**  
Signal level: For crest factor CF3, more than 30% of range  
For crest factor CF6/6 A, more than 60% of range  
When the frequency is smaller than or equal to 2 times of the above lower frequency, the input level of more than 50% of ranges is necessary.  
Frequency filter: 0.1 Hz ≤ f < 100 Hz: 100 Hz  
100 Hz ≤ f < 1 kHz: 1 kHz  
1 kHz ≤ f < 100 kHz: 100 kHz

**Harmonic Measurement**

**Measurement target** All installed elements

**Method** PLL synchronization method

**Frequency range** Fundamental frequency: 0.1 Hz to 300 kHz  
Analysis frequency: 0.1 Hz to 1.5 MHz

**PLL source** Select the voltage or current of input elements, or the external clock.  
Input level: See element specifications  
The condition under frequency filter ON is the same as frequency measurement.  
Condition of frequency filter ON  
0.1 Hz < f < 100 Hz: 100 Hz  
100 Hz < f < 1 kHz: 1 kHz  
1 kHz < f < 10 kHz: 10 kHz  
10 kHz < f < 100 kHz: 100 kHz

**FFT points** Select from 1024 or 8192

**Window function** Rectangular

**Anti-aliasing filter** Set with line filter and harmonic filter

**FFT points 8192 (10 MS/s)**

Fundamental frequency	Sampling rate	Window width	Upper limit of measured order	
			U, I, P, $\phi$ , $\phi_U$ , $\phi_I$	Other measured values
0.5 Hz to 3 kHz	f × 1024	8 waves	500* order	100 order
3 kHz to 7.5 kHz	f × 1024	8 waves	200* order	100 order
7.5 kHz to 15 kHz	f × 512	16 waves	100 order	100 order
15 kHz to 30 kHz	f × 256	32 waves	50 order	50 order
30 kHz to 75 kHz	f × 128	64 waves	20 order	20 order
75 kHz to 150 kHz	f × 64	128 waves	10 order	10 order
150 kHz to 300 kHz	f × 32	256 waves	5 order	5 order

\*Upper limit of measured order is 100 or smaller, when Update Rate is set to 50 ms.

**Accuracy**  
PLL source input level  
15 V or more of range for voltage input.  
200 mV or more of range for external current sensor input.  
50% or more of the measurement range rating for crest factor CF3.  
100% or more of the measurement range rating for crest factor CF6/CF6A.  
For 500 mA, 1 A, 2 A range, 20 Hz to 1 kHz.

**Accuracy**  
Add the following accuracy to the normal measurement accuracy.  
• When the line filter is OFF

Frequency	Voltage, Current
0.1 Hz ≤ f < 10 Hz	±(0.01% of reading + 0.03% of range)
10 Hz ≤ f < 45 Hz	±(0.01% of reading + 0.03% of range)
45 Hz ≤ f ≤ 66 Hz	±(0.01% of reading + 0.03% of range)
66 Hz < f ≤ 440 Hz	±(0.01% of reading + 0.03% of range)
440 Hz < f ≤ 1 kHz	±(0.01% of reading + 0.03% of range)
1 kHz < f ≤ 10 kHz	±(0.01% of reading + 0.03% of range)
10 kHz < f ≤ 50 kHz	±(0.05% of reading + 0.1% of range)
50 kHz < f ≤ 100 kHz	±(0.1% of reading + 0.2% of range)
100 kHz < f ≤ 500 kHz	±(0.1% of reading + 0.5% of range)
500 kHz < f ≤ 1.5 MHz	±(0.5% of reading + 2% of range)

Frequency	Power
0.1 Hz ≤ f < 10 Hz	±(0.02% of reading + 0.06% of range)
10 Hz ≤ f < 45 Hz	±(0.02% of reading + 0.06% of range)
45 Hz ≤ f ≤ 66 Hz	±(0.02% of reading + 0.06% of range)
66 Hz < f ≤ 440 Hz	±(0.02% of reading + 0.06% of range)
440 Hz < f ≤ 1 kHz	±(0.02% of reading + 0.06% of range)
1 kHz < f ≤ 10 kHz	±(0.02% of reading + 0.06% of range)
10 kHz < f ≤ 50 kHz	±(0.1% of reading + 0.2% of range)
50 kHz < f ≤ 100 kHz	±(0.2% of reading + 0.4% of range)
100 kHz < f ≤ 500 kHz	±(0.2% of reading + 1% of range)
500 kHz < f ≤ 1.5 MHz	±(1% of reading + 4% of range)

**General specifications (including WT5000 main body)**

**Warm-up time** About 30 minutes

**Operation environment**  
Temperature 5 to 40°C  
Humidity 20 to 80% RH (no condensation)  
Operating altitude 2000 m or lower  
Installation location Indoors

**Storage environment**  
Temperature -25 to 60°C (no condensation)  
Humidity 20 to 80% RH (no condensation)

**Rated power supply voltage** 100 to 120 VAC, 220 to 240 VAC

**Allowable power supply voltage fluctuation range** 90 to 132 VAC, 198 to 264 VAC

**Rated power supply frequency** 50/60 Hz

**Allowable power supply frequency fluctuation range** 48 Hz to 63 Hz

**Power consumption** Maximum 560 VA

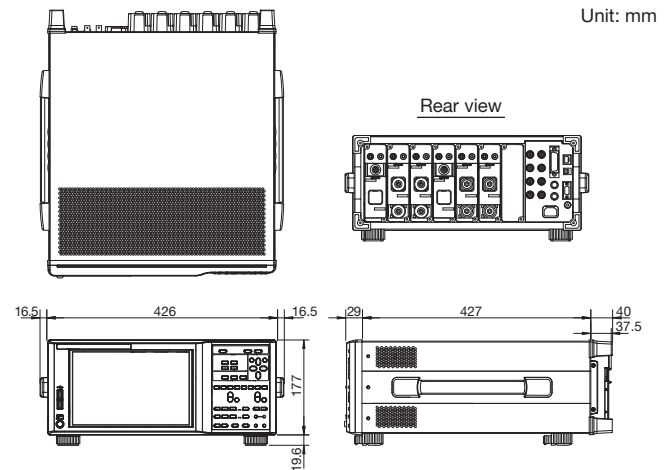

30 A and 5 A High Accuracy Elements (760901 and 760902) include LAZER source inside.

**CLASS 1 LASER PRODUCT**  
クラス1レーザー製品  
1类激光产品  
(EN 60825-1:2014)  
(IEC 60825-1:2007, GB 7247.1-2012)

Complies with 21 CFR 1040.10 and 1040.11  
except for deviations pursuant to Laser  
Notice No.50, dated June 24, 2007  
2-9-32 Nakacho, Musashino-shi,  
Tokyo 180-8750, Japan

# Software

*Coming soon*

## Real-time control over multichannel power measurements

Easily monitor, control and download measurements from users PC. The WTViewerE software enables PC connectivity for all Yokogawa power analyzers such as the WT5000, WT3000E, WT1800E, WT500 and WT300E Series through Ethernet, USB, GPIB or RS232 allowing users to easily control, monitor, record, analyze, and save measurements remotely.



### Real-time control

WTViewerE allows users to remotely control and analyze measurements in real-time or previously acquired data. In online mode, users have real time control of measurements from each connected instrument, allowing them to remotely start or stop integration or collect live measurements. In offline mode users can analyze the latest acquired or previously stored data.

### Versatile display for Multi-Channel Measurements

WTViewerE supports split screen displays for multichannel power measurements, allowing users to customize analysis. The software can simultaneously display up to 12 waveforms, 12 trends, 8 vectors and 6 harmonic bar graphs. Users can also save and load screen layout configurations.

### Multi-unit Connectivity



WTViewerE enables synchronized measurements of up to four WT instruments in any combination regardless of model, element type or option. The software automatically detects connected instruments and displays a list from which users can modify wiring systems, measurement ranges, update intervals, synchronization sources, display formats and other measurement conditions.















With customizable split screen display of readings in numeric, bar, trend or vector formats, the WTViewerE simplifies the acquisition, storage and analysis of multichannel measurements from up to 4 power analyzers simultaneously.

# Accessories

## Related products

<p><b>AC/DC Current Sensor</b></p>  <p><b>CT60/CT200/CT1000/CT2000A</b> <span style="background-color: yellow;">Current Output</span></p> <p><b>AC/DC Current Sensors</b></p> <ul style="list-style-type: none"> <li>• DC to 800 kHz/60 Apeak, DC to 500 kHz/200 Apeak, DC to 300 kHz/1000 Apeak, DC to 40 kHz/2000 Arms (3000 Apeak)</li> <li>• Wide dynamic range –2000 A to 0 A to +2000 A (DC)/2000 Arms (AC)</li> <li>• Wide measurement frequency range: DC and up to 800 kHz</li> <li>• High-precision fundamental accuracy: ±(0.05% of reading + 30 µA)</li> <li>• ±15 V DC power supply, connector, and load resistor required.</li> </ul> <p>For detailed information, see Current Sensors &amp; Accessories Catalog Bulletin CT1000-00E.</p>	<p><b>Clamp on Probe</b></p>  <p><b>751552</b> <span style="background-color: yellow;">Current Output</span></p> <p><b>Current Clamp on Probe</b></p> <ul style="list-style-type: none"> <li>• AC 1000 Arms (1400 Apeak)</li> <li>• Measurement frequency range: 30 Hz to 5 kHz</li> <li>• Basic accuracy: ±0.3% of reading</li> <li>• Maximum allowed input: AC 1000 Arms, maximum 1400 Apeak (AC)</li> <li>• Current output type: 1 mA/A</li> </ul> <p>A separately sold Safety terminal adapter set (761952), measurement leads (758917), etc. are required for connection to WT5000. For detailed information, see Power Meter Accessory Catalog Bulletin CT1000-00E.</p>	<p><b>Current Sensor Unit</b></p>  <p><b>751522, 751524</b> <span style="background-color: yellow;">Current Output</span></p> <p><b>Current Sensor Unit</b></p> <ul style="list-style-type: none"> <li>• DC to 100 kHz/1000 Apeak</li> <li>• Wide dynamic range: –1000 A to 0 A to +1000 A (DC)/1000 Apeak (AC)</li> <li>• Wide measurement frequency range: DC to 100 kHz (–3 dB)</li> <li>• High-precision fundamental accuracy: ±(0.05% of reading + 40 µA)</li> <li>• Superior noise withstanding ability and CMRR characteristic due to optimized casing design</li> </ul> <p>751522/751524 do not conform to CE Marking For detailed information, see Power Meter Accessory Catalog Bulletin CT1000-00E.</p>
--	--	---

**Adapters and Cables**

 <p><b>758917</b></p> <p><b>Measurement leads</b></p> <p>Two leads in a set. Use 758917 in combination with 758922 or 758929. Total length: 75 cm. Rating: 1000 V CAT II, 32 A</p>	 <p><b>758922</b> <span style="background-color: yellow;">Warning</span></p> <p><b>Small alligator adapters</b></p> <p>For connection to measurement leads (758917). Two in a set. Rating: 300 V CAT II</p>	 <p><b>758929</b> <span style="background-color: yellow;">Warning</span></p> <p><b>Large alligator adapters</b></p> <p>For connection to measurement leads (758917). Two in a set. Rating: 1000 V CAT II</p>	 <p><b>758923<sup>*1</sup></b></p> <p><b>Safety terminal adapter set</b></p> <p>Spring-hold type. Two adapters in a set.</p>	 <p><b>758931<sup>*1</sup></b></p> <p><b>Safety terminal adapter set</b></p> <p>Screw-fastened adapters. Two adapters in a set. 1.5 mm Allen wrench included for tightening.</p>	 <p><b>758924</b></p> <p><b>Conversion adapter</b></p> <p>For conversion between male BNC and female banana plug</p>
 <p><b>366924/25<sup>*2</sup></b> <span style="background-color: yellow;">Warning</span></p> <p><b>BNC cable</b></p> <p>BNC-BNC 1 m/2 m. For simultaneous measurements with 2 units or for an external trigger signal.</p>	 <p><b>B9284LK<sup>*3</sup></b> <span style="background-color: yellow;">Warning</span></p> <p><b>External Sensor Cable</b></p> <p>To connect the external input of the WT1800E to the current sensor. Length: 50 cm</p>	 <p><b>701902/03</b></p> <p><b>Safety BNC cable</b></p> <p>BNC-BNC 1 m/2 m. To connect the Motor evaluation function to a torque sensor.</p>	 <p><b>761951</b></p> <p><b>Safety terminal adapter set</b></p> <p>Screw-fastened type adapters for 30 A element. Black/Red two adapters in a set.</p>	 <p><b>761953</b></p> <p><b>Safety terminal adapter set</b></p> <p>Screw-fastened type adapters for 5 A element. Black/Red two adapters in a set.</p>	 <p><b>761952</b></p> <p><b>Safety terminal conversion adapter set</b></p> <p>Female-female type adapters for 5 A element. Black/Red two adapters in a set. <sup>*1</sup>When using this, terminal shape is the same as the voltage input, please pay attention to miswiring.</p>

Warning Due to the nature of this product, it is possible to touch its metal parts. Therefore, there is a risk of electric shock, so the product must be used with caution.

<sup>\*1</sup> Maximum diameters of cables that can be connected to the adapters 758923 core diameter: 2.5 mm or less; sheath diameter: 4.8 mm or less 758931 core diameter: 1.8 mm or less; sheath diameter: 3.9 mm or less

<sup>\*2</sup> Use with a low-voltage circuit (42 V or less)

<sup>\*3</sup> The coax cable is simply cut on the current sensor side. Preparation by the user is required.

**Typical Voltage/Current Connections**

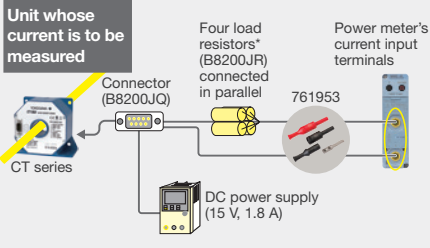
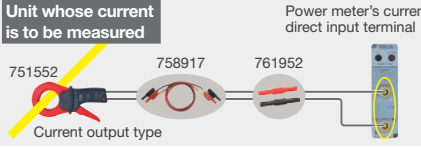
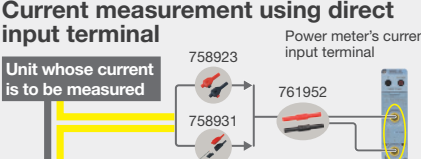
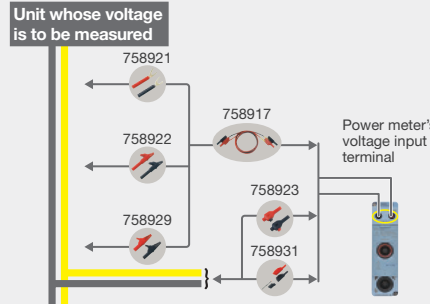
<p><b>Measurement using current sensor</b></p> <p>Connection example</p>  <p>Unit whose current is to be measured</p> <p>Four load resistors* (B8200JR) connected in parallel</p> <p>Power meter's current input terminals</p> <p>Connector (B8200JQ)</p> <p>CT series</p> <p>DC power supply (15 V, 1.8 A)</p> <p>761953</p>	<p><b>Measurement using clamp-on probe</b></p>  <p>Unit whose current is to be measured</p> <p>Power meter's current direct input terminal</p> <p>751552 758917 761952</p> <p>Current output type</p> <p><b>Current measurement using direct input terminal</b></p>  <p>Unit whose current is to be measured</p> <p>Power meter's current input terminal</p> <p>758923 761952 758931</p>	<p><b>Measurement using voltage input terminal</b></p>  <p>Unit whose voltage is to be measured</p> <p>Power meter's voltage input terminal</p> <p>758921 758917 758922 758929 758923 758931</p>
--	--	---

\*A burden resistor is required for the CT1000, CT200 and CT60.

## Model and Suffix code

Model	Suffix Code	Descriptions
WT5000		Precision Power Analyzer
	-HE	English menu
	-D	UL/CSA Standard, PSE compliant
	-F	VDE/Korean Standard
	-H	Chinese Standard
	-N	Brazilian Standard
	-Q	BS Standard
	-R	Australian Standard
	-T	Taiwanese Standard
	/M1	32 GB Built-in Memory
	/MTR1	Motor Evaluation 1
	/DA20*	20 CH D/A Output
	/MTR2*	Motor Evaluation 2

\*When select from these options, please select only one. /MTR2 option requires installation of /MTR1 option.

Model	Suffix Code	Descriptions
760901		30 A High Accuracy Element
760902		5 A High Accuracy Element

### Standard accessories

WT5000: Power cord, Rubber feet, Cover panel B8216JA 7 sets, User's manual, expanded user's manual, communication interface user's manual, connector (provided only with/DA20),  
760901/760902: Safety terminal adapter B9317WB/B9317WC (provided two adapters in a set times input element number) Safety terminal adapter A1650JZ/A1651JZ (provided black/red two adapters in a set, times of 30 A input element number), Safety terminal adapter B8213YA/B8213YB (provided black/red two adapters in a set, times of 5 A input element number)

### User's manuals

Start guide (booklet), function/operation, communication manuals (electric file)

■ Any company's names and product names mentioned in this document are trade names, trademarks or registered trademarks of their respective companies.

### NOTICE

- Before operating the product, read the user's manual thoroughly for proper and safe operation.





### Yokogawa's Approach to Preserving the Global Environment

- Yokogawa's electrical products are developed and produced in facilities that have received ISO14001 approval.
- In order to protect the global environment, Yokogawa's electrical products are designed in accordance with Yokogawa's Environmentally Friendly Product Design Guidelines and Product Design Assessment Criteria.

This is a Class A instrument based on Emission standards EN61326-1 and EN55011 and is designed for an industrial environment.

Operation of this equipment in a residential area may cause radio interference, in which case users will be responsible for any interference which they cause.

## Accessory (sold separately)

Model number	Product	Description
366924	 BNC-BNC Cable	1 m
366925	 BNC-BNC Cable	2 m
701901	1:1 Safety BNC Adapter Lead	1000 V CAT II for /MTR1, /MTR2
701902	Safety BNC-BNC Cable	1000 V CAT II, 1 m for /MTR1, /MTR2
701903	Safety BNC-BNC Cable	1000 V CAT II, 2 m for /MTR1, /MTR2
720930	Current clamp probe	40 Hz to 3.5 kHz, AC50 A
720931	Current clamp probe	40 Hz to 3.5 kHz, AC200 A
751542-E4	Rack Mounting Kit	For EIA
751542-J4	Rack Mounting Kit	For JIS
758917	Test Lead Set	A set of 0.75 m long, red and black test leads
758922	 Small Alligator-clip	Rated at 300 V CAT II two in a set
758923	Safety Terminal Adapter	Two adapters to a set (spring-hold type)
758924	Conversion Adapter	BNC-banana-Jack (female) adapter
758929	 Large Alligator-clip	Rated at 1000 V CAT II and used in a pair
758931	Safety Terminal Adapter Set	Two adapters to a set (Screw-fastened type), 1.5 mm hex Wrench is attached.
761941 <sup>2</sup>	WTViewerE	Viewer software for WT series
761951	Safety Terminal Adapter Set	Two adapters to a set for 30 A current (6 mm screw-fastened type)
761952	Safety Terminal Conversion Adapter Set	Two adapters to a set for 5 A current (female-female type)
761953	Safety Terminal Adapter Set	Two adapters to a set for 5 A current (screw-fastened type using B9317WD)
CT60	AC/DC Current Sensor	Maximum 60 Apeak, DC to 800 kHz (-3 dB)
CT200	AC/DC Current Sensor	Maximum 200 Apeak, DC to 500 kHz (-3 dB)
CT1000	AC/DC Current Sensor	Maximum 1000 Apeak, DC to 300 kHz (-3 dB)
CT2000A	AC/DC Current Sensor	Maximum 2000 Arms, DC to 40 kHz (-3 dB)

Parts number	Product	Description	Order Q'ty
B9284LK	 External Sensor Cable	Current sensor input connector, Length 0.5 m	1
B9317WD	Wrench	For 761953	1

 Due to the nature of this product, it is possible to touch its metal parts. Therefore, there is a risk of electric shock, so the product must be used with caution.

\*1: Use these products with low-voltage circuits (42 V or less).

\*2: The WT5000 will be supported soon.

# YOKOGAWA

<https://tmi.yokogawa.com/>

YMI-KS-MI-SE06

## YOKOGAWA TEST & MEASUREMENT CORPORATION

Global Sales Dept. /Phone: +81-422-52-6237 E-mail: tm@cs.jp.yokogawa.com  
Facsimile: +81-422-52-6462

The contents in this catalog is as of September 2018. Subject to change without notice.

Copyright © 2018, Yokogawa Test & Measurement Corporation

[Ed: 01/b]

Printed in Japan, 809(KP)

## YOKOGAWA CORPORATION OF AMERICA

### YOKOGAWA EUROPE B.V.

### YOKOGAWA SHANGHAI TRADING CO., LTD.

### YOKOGAWA ELECTRIC KOREA CO., LTD.

### YOKOGAWA ENGINEERING ASIA PTE. LTD.

### YOKOGAWA INDIA LTD.

### YOKOGAWA ELECTRIC CIS LTD.

### YOKOGAWA AMERICA DO SUL LTDA.

### YOKOGAWA MIDDLE EAST & AFRICA B.S.C(c)

Phone: +31-88-4641000

Phone: +86-21-6239-6363

Phone: +82-2-2628-3810

Phone: +65-6241-9933

Phone: +91-80-4158-6396

Phone: +7-495-737-78-68

Phone: +55-11-3513-1300

Phone: +973-17-358100

E-mail: tmi@us.yokogawa.com

E-mail: tmi@nl.yokogawa.com

E-mail: tech@ysh.com.cn

E-mail: TMI@kr.yokogawa.com

E-mail: TMI@sg.yokogawa.com

E-mail: tmi@in.yokogawa.com

E-mail: info@ru.yokogawa.com

E-mail: tm@br.yokogawa.com

E-mail: help.ymatmi@bh.yokogawa.com

Facsimile: +86-21-6880-4987

Facsimile: +82-2-2628-3899

Facsimile: +65-6241-9919

Facsimile: +91-80-2852-1442

Facsimile: +7-495-737-78-69

Facsimile: +973-17-336100