

# MCTS II

## Multi Channel Current Transducer System

### Specifications



# Electronics-Rack

- Modular system for up to six transducer power supply channels
- Galvanic separation between channels
- Standard transducer status readout interface
- Supply voltage for active burden modules
- 19"-rack mountable device



MCTS II Front



MCTS II Rear

General Data	
Operation Temperature:	-10 ... 60 °C
Operation Humidity:	20 ... 90 % RH, noncondensing
Warranty period:	36 Months

Electrical Data	
Supply voltage:	100-240 VAC, 50/60 Hz, fused with 6 A slow blow
Output voltages:	+ 15 V <sub>DC</sub> , 3.4 A <sub>max</sub> / -15 V <sub>DC</sub> , 2.0 A <sub>max</sub>
Max. Power Consumption:	The maximum power consumption depends on the number of channels installed, the number of transducers connected and the current consumption of each transducer. The maximum power consumption of a six channel MCTS with transducers IN 2000-S at 2000 A <sub>rms</sub> primary current is around 175 W.

**Power and Transducer Status Functions**

Channel and transducer status are visible at the MCTS front panel and can be read out via the Status-Readout Interface

	Power LED green:	Channel installed
	Power LED off:	Channel not installed
	Status LED green:	Transducer ok
	Status LED red:	Transducer overload or open output

	<p>This interface gives out the transducer status by means of potential free relay contacts.</p> <p>Switching voltage: 200 V</p> <p>Switching current: 2 A</p> <p>A status readout cable is available as an option.</p>
--	---

Status-Readout-Interface

**DC-voltage output for active burden modules**

	<p>Normally the current transducers for higher primary current levels are not able to drive much more than 1 V at the output. If this is enough, our passive plug-on burden resistors are the right solution to get a mV/A-signal out of the sensor. If the connected measurement instrument demands a higher voltage signal level, our active plug-on voltage modules are the right solution. These deliver 7 V<sub>rms</sub> (± 9.9 V<sub>pk</sub>) at transducer nominal primary current.</p>
--	--

# Current Transducers

Type	CT 100	CT 200	CT 400	CT 500	CT 1000	CT 2000
<b>Current Range</b>	100 A	200 A	400 A	500 A	1000 A	2000 A
<b>DC / AC<sub>rms</sub> (Crestfactor 2)</b>						
<b>100 ms Overload</b>	20 kA <sub>pk</sub>	20 kA <sub>pk</sub>	20 kA <sub>pk</sub>	3 kA <sub>pk</sub>	5 kA <sub>pk</sub>	10 kA <sub>pk</sub>
<b>Ratio</b>	500 : 1	1000 : 1	1500 : 1	750 : 1	1500 : 1	2000 : 1
<b>Output Range</b>	0 ... 200 mA <sub>rms</sub>	0 ... 200 mA <sub>rms</sub>	0 ... 266.667 mA <sub>rms</sub>	0 ... 666.667 mA <sub>rms</sub>	0 ... 666.667 mA <sub>rms</sub>	0 ... 1 A <sub>rms</sub>
<b>Max. Measuring Resistance<sup>1</sup></b>	25 Ω	20 Ω	10 Ω	5 Ω	4 Ω	3.5 Ω
<b>Bandwidth (-3 dB)</b>	DC ... 2 MHz	DC ... 1.1 MHz	DC ... 800 kHz	DC ... 520 kHz	DC ... 440 kHz	DC ... 140 kHz
<b>Step Response (0 ... 90 %)</b>	0.2 μs	0.2 μs	1 μs	1 μs	1 μs	1 μs
<b>DC Accuracy (of MR)<sup>2</sup></b>	0.002 %	0.001 %	0.0008 %	0.0011 %	0.0012 %	0.0012 %
<b>AC Accuracy (of MV)<sup>3</sup></b>						
> 0 ... ≤ 100 Hz	0.015 %	0.015 %	0.015 %	0.015 %	0.015 %	0.015 %
> 100 ... ≤ 1000 Hz	0.025 %	0.02 %	0.02 %	0.02 %	0.02 %	0.05 %
> 1000 ... ≤ 10000 Hz	0.2 %	0.15 %	0.15 %	0.1 %	0.15 %	0.25 %
> 10000 ... ≤ 50000 Hz <sup>4</sup>	0.5 %	0.5 %	0.5 %	0.2 %	1.5 %	1 % <sup>4</sup>
> 50000 ... ≤ 100000 Hz	1 %	1 %	1 %	0.5 %	4 %	
<b>Angular Accuracy</b>						
> 0 ... ≤ 100 Hz	0.01 °	0.01 °	0.01 °	0.01 °	0.01 °	0.01 °
> 100 ... ≤ 1000 Hz	0.05 °	0.02 °	0.01 °	0.01 °	0.01 °	0.05 °
> 1000 ... ≤ 10000 Hz	0.1 °	0.05 °	0.1 °	0.05 °	0.1 °	0.1 °
> 10000 ... ≤ 50000 Hz <sup>4</sup>	0.25 °	0.25 °	0.5 °	0.5 °	1 °	1 ° <sup>4</sup>
> 50000 ... ≤ 100000 Hz	0.5 °	0.5 °	1 °	1 °	2 °	
<b>Temp.-Coefficient (of MR)</b>	0.2 ppm/K	0.2 ppm/K	0.1 ppm/K	1 ppm/K	0.3 ppm/K	0.1 ppm/K
<b>Temperature Range</b>	-40 ... 85 °C	-40 ... 85 °C	-40 ... 85 °C	-40 ... 85 °C	-40 ... 85 °C	-40 ... 85 °C
<b>Test Voltage 50 Hz</b>	4.95 kV	4.95 kV	4.95 kV	4.2 kV	4.2 kV	6 kV
<b>Inner Diameter</b>	28 mm	28 mm	28 mm	38 mm	38 mm	70 mm
<b>Mass</b>	0.275 kg	0.295 kg	0.305 kg	1.3 kg	1.3 kg	4.2 kg

<sup>1</sup> At full scale and 25 °C. For other current values and temperatures see graphs below. Max measuring resistance = cable loop resistance + burden resistance (see page 5).

<sup>2</sup> Error of measuring range. At 25 °C.

<sup>3</sup> Error of measured value. For range 3 % ... 100 %. Test current 0 ... 100 Arms, DC ... 100 kHz. At 25 °C.

<sup>4</sup> CT 2000: 10000 ... ≤ 20000 Hz. The precision frequency range of CT 2000 is limited to 20 kHz.

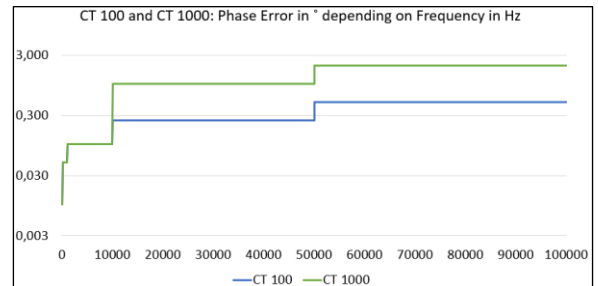
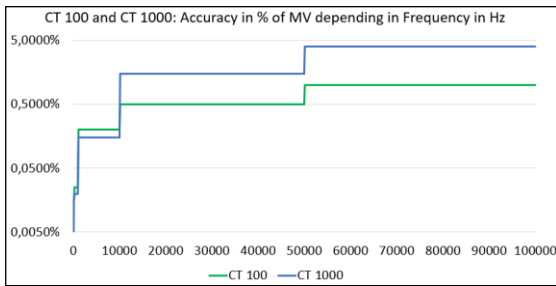

## Maximum measuring resistance (cable- + burden-resistance) depending on primary rms current and surrounding temperature

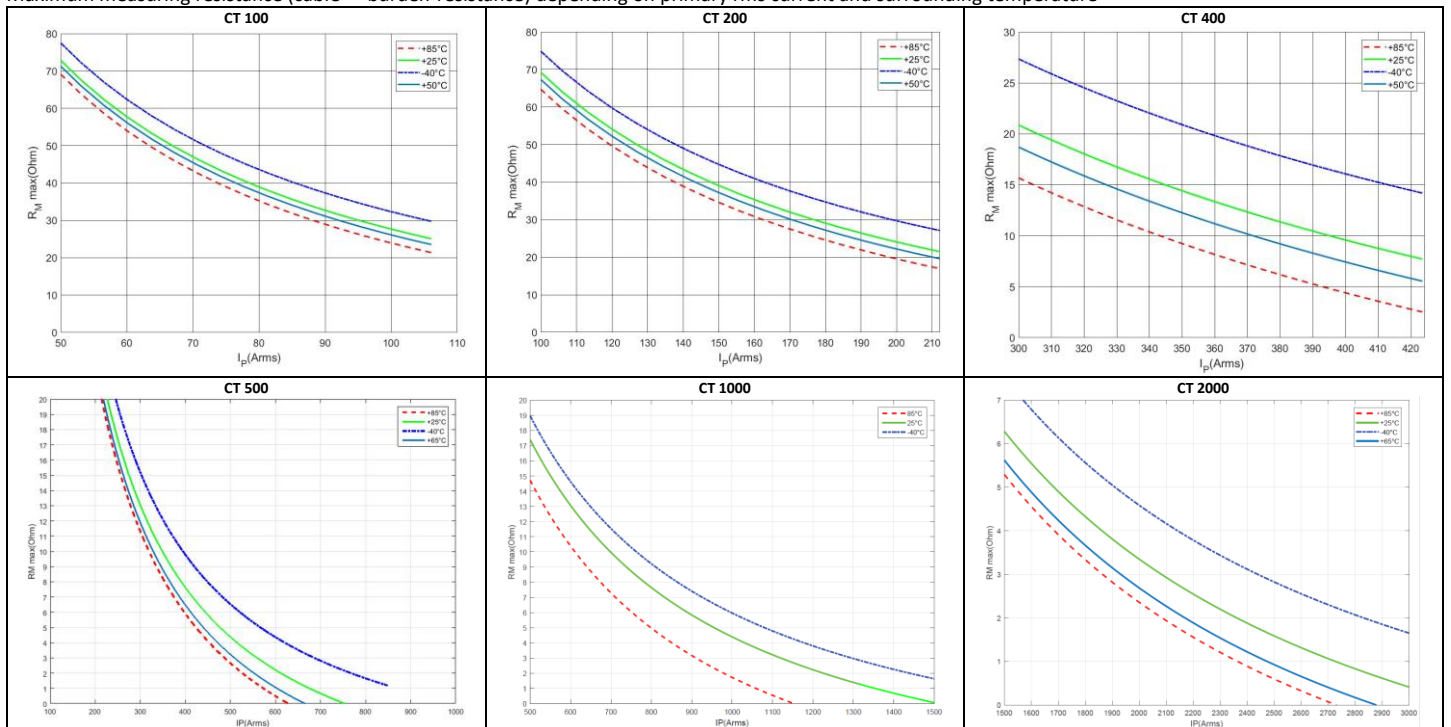

# Burden Modules



The transducer system delivers the transducer output current at the 4 mm output terminals on the back panel of the rack. For those instruments that don't have current input terminals, optional high precision passive and active plug-on burden modules with very low phase angle error are available. The active voltage output modules are supplied by the MCTS rack with a 3-pole D-SUB connector.

## Passive plug-on burden resistors



Passive plug-on burden resistors are available from 1 Ω to 50 Ω. The burden resistor is limited by the transducer and the length of the connection cable. For higher output voltages active plug-on burden amplifiers are available.

Order Number	Resistance Value	Accuracy	Frequency Influence	Phase Error	Bandwidth	Max. Output Voltage	Load Influence
MCTS/BR1/0.02	1 Ω	0.02 % of MV	0.0005 %/kHz	< 1° @ 100 kHz	> 1 MHz	1.00 V <sub>rms</sub> @ 1000 mA <sub>rms</sub>	< 0.1 ppm/mW
MCTS/BR1.5/0.02	1.5 Ω	0.02 % of MV	0.0005 %/kHz	< 1° @ 100 kHz	> 1 MHz	1.00 V <sub>rms</sub> @ 667 mA <sub>rms</sub>	< 0.1 ppm/mW
MCTS/BR2.5/0.02	2.5 Ω	0.02 % of MV	0.0005 %/kHz	< 1° @ 100 kHz	> 1 MHz	1.58 V <sub>rms</sub> @ 632 mA <sub>rms</sub>	< 0.1 ppm/mW
MCTS/BR3.75/0.02	3.75 Ω	0.02 % of MV	0.0005 %/kHz	< 1° @ 100 kHz	> 1 MHz	1.94 V <sub>rms</sub> @ 516 mA <sub>rms</sub>	< 0.1 ppm/mW
MCTS/BR5/0.02	5 Ω	0.02 % of MV	0.0005 %/kHz	< 1° @ 100 kHz	> 1 MHz	2.24 V <sub>rms</sub> @ 447 mA <sub>rms</sub>	< 0.1 ppm/mW
MCTS/BR10/0.01	10 Ω	0.01 % of MV	0.0005 %/kHz	< 1° @ 100 kHz	> 1 MHz	3.16 V <sub>rms</sub> @ 316 mA <sub>rms</sub>	< 0.1 ppm/mW
MCTS/BR25/0.01	25 Ω	0.01 % of MV	0.0005 %/kHz	< 1° @ 100 kHz	> 1 MHz	5.00 V <sub>rms</sub> @ 200 mA <sub>rms</sub>	< 0.1 ppm/mW
MCTS/BR50/0.01	50 Ω	0.01 % of MV	0.0005 %/kHz	< 1° @ 100 kHz	> 1 MHz	7.07 V <sub>rms</sub> @ 141 mA <sub>rms</sub>	< 0.1 ppm/mW

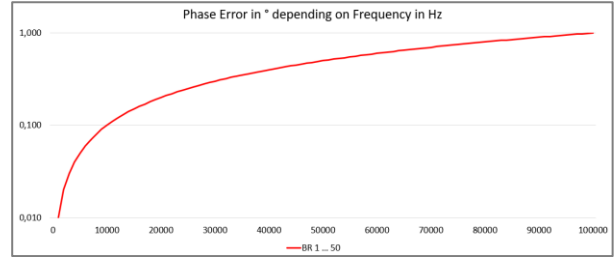
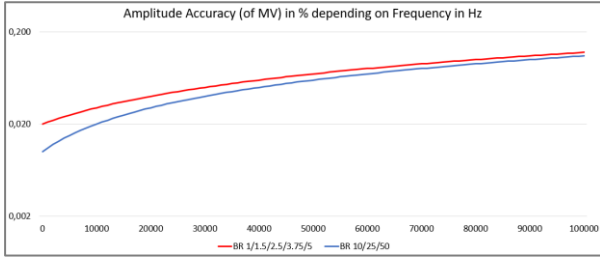

### Resulting scaling with standard transducer / passive burden-combinations

Transducer	Passive BR	Scaling	Output Voltage
CT 100	MCTS/BR10/0.01	20 mV/A	2 V <sub>rms</sub> @ 100 A <sub>rms</sub>
CT 200	MCTS/BR10/0.01	10 mV/A	2 V <sub>rms</sub> @ 200 A <sub>rms</sub>
CT 400	MCTS/BR3.75/0.02	2.5 mV/A	1 V <sub>rms</sub> @ 400 A <sub>rms</sub>
CT 500	MCTS/BR1.5/0.02	2 mV/A	1 V <sub>rms</sub> @ 500 A <sub>rms</sub>
CT 1000	MCTS/BR1.5/0.02	1 mV/A	1 V <sub>rms</sub> @ 1000 A <sub>rms</sub>
CT 2000	MCTS/BR1/0.02	0.5 mV/A	1 V <sub>rms</sub> @ 2000 A <sub>rms</sub>

## Active plug-on voltage output modules



The output voltage level the transducer can drive is limited. The active plug-on burden modules combine a very precise burden resistor with a highly accurate voltage amplifier. The plug-on burden voltage modules deliver 7 V<sub>rms</sub> (± 9.9 V<sub>pk</sub>) at transducer nominal value.

Order Number	Input Resistance	Accuracy	Max. Output Voltage	Bandwidth	Phase Error	Load Influence
MCTS/VM1/0.02	1 Ω	0.01 % of MV + 0.01 % of MR	7 V <sub>rms</sub> @ 1000 mA <sub>rms</sub>	> 300 kHz	< 1° @ 100 kHz	< 0.1 ppm/mW
MCTS/VM0.66/0.02	1.5 Ω	0.01 % of MV + 0.01 % of MR	7 V <sub>rms</sub> @ 667 mA <sub>rms</sub>	> 300 kHz	< 1° @ 100 kHz	< 0.1 ppm/mW
MCTS/VM0.4/0.02	2.5 Ω	0.01 % of MV + 0.01 % of MR	7 V <sub>rms</sub> @ 400 mA <sub>rms</sub>	> 300 kHz	< 1° @ 100 kHz	< 0.1 ppm/mW
MCTS/VM0.26/0.02	3.75 Ω	0.01 % of MV + 0.01 % of MR	7 V <sub>rms</sub> @ 267 mA <sub>rms</sub>	> 300 kHz	< 1° @ 100 kHz	< 0.1 ppm/mW
MCTS/VM0.2/0.02	5 Ω	0.01 % of MV + 0.01 % of MR	7 V <sub>rms</sub> @ 200 mA <sub>rms</sub>	> 300 kHz	< 1° @ 100 kHz	< 0.1 ppm/mW
MCTS/VM0.1/0.02	10 Ω	0.01 % of MV + 0.01 % of MR	7 V <sub>rms</sub> @ 100 mA <sub>rms</sub>	> 300 kHz	< 1° @ 100 kHz	< 0.1 ppm/mW

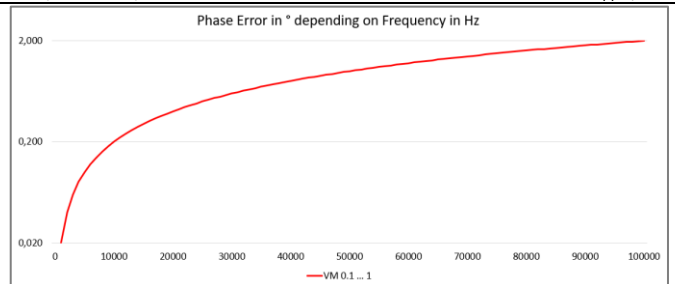
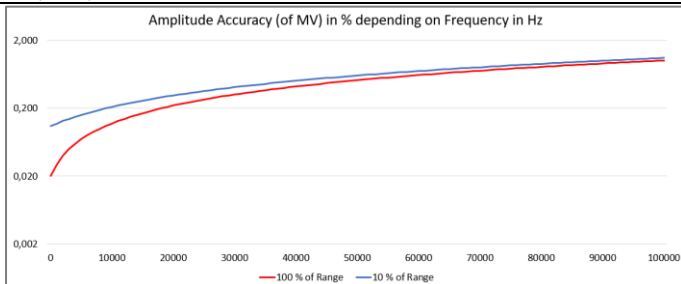

### Resulting scaling with standard transducer / active burden-combinations

Transducer	Active VM	Scaling	Output Voltage
CT 100	MCTS/VM0.2/0.02	70 mV/A	7 V <sub>rms</sub> @ 100 A <sub>rms</sub>
CT 200	MCTS/VM0.2/0.02	35 mV/A	7 V <sub>rms</sub> @ 200 A <sub>rms</sub>
CT 400	MCTS/VM0.26/0.02	17.5 mV/A	7 V <sub>rms</sub> @ 400 A <sub>rms</sub>
CT 500	MCTS/VM0.66/0.02	14 mV/A	7 V <sub>rms</sub> @ 500 A <sub>rms</sub>
CT 1000	MCTS/VM0.66/0.02	7 mV/A	7 V <sub>rms</sub> @ 1000 A <sub>rms</sub>
CT 2000	MCTS/VM1/0.02	3.5 mV/A	7 V <sub>rms</sub> @ 2000 A <sub>rms</sub>

# Connection Cables



Connection cables from the MCTS rack to the transducers are available in various cable lengths. Special cable lengths can be manufactured according demand. Be aware that the cable resistance is part of the maximum measuring resistance mentioned in the transducer data sheets. The cables are available with two different wire cross sections, 0.34 mm<sup>2</sup> and 0.75 mm<sup>2</sup>.

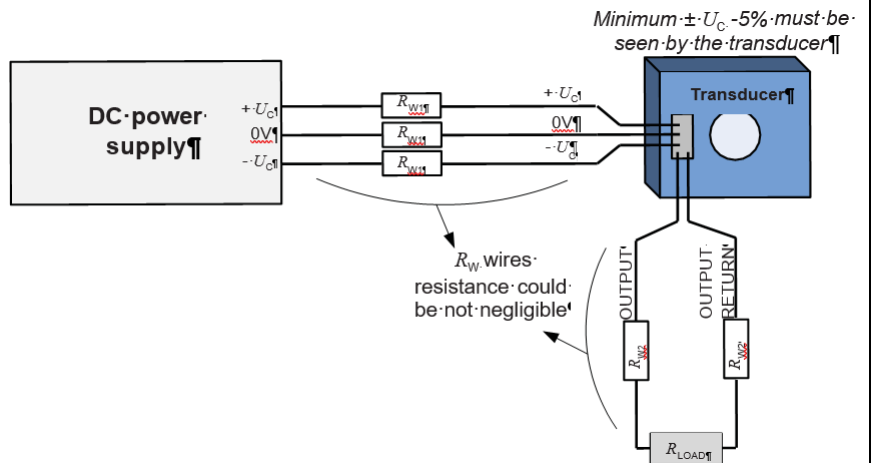

## Standard Connection Cables

Order Number	Cable Length	Wire Cross Section	Single Wire Resistance	Loop Resistance (4 x $R_{WIRE}$ )	Mass
MCTS/TPS/1	1 m	0.34 mm <sup>2</sup>	0.05 Ω	0.21 Ω	0.15 kg
MCTS/TPS/1.5	1.5 m	0.34 mm <sup>2</sup>	0.08 Ω	0.31 Ω	0.21 kg
MCTS/TPS/2.5	2.5 m	0.34 mm <sup>2</sup>	0.13 Ω	0.52 Ω	0.28 kg
MCTS/TPS/3	3 m	0.34 mm <sup>2</sup>	0.16 Ω	0.63 Ω	0.32 kg
MCTS/TPS/5	5 m	0.34 mm <sup>2</sup>	0.26 Ω	1.05 Ω	0.47 kg
MCTS/TPS/10	10 m	0.34 mm <sup>2</sup>	0.52 Ω	2.09 Ω	0.84 kg
MCTS/TPS/15	15 m	0.34 mm <sup>2</sup>	0.79 Ω	3.14 Ω	1.21 kg
MCTS/TPS/20	20 m	0.34 mm <sup>2</sup>	1.05 Ω	4.19 Ω	1.58 kg
MCTS/TPS/2.5/0.75	2.5 m	0.75 mm <sup>2</sup>	0.06 Ω	0.24 Ω	0.37 kg
MCTS/TPS/5/0.75	5 m	0.75 mm <sup>2</sup>	0.12 Ω	0.47 Ω	0.65 kg
MCTS/TPS/10/0.75	10 m	0.75 mm <sup>2</sup>	0.24 Ω	0.95 Ω	1.15 kg
MCTS/TPS/15/0.75	15 m	0.75 mm <sup>2</sup>	0.36 Ω	1.42 Ω	1.70 kg
MCTS/TPS/20/0.75	20 m	0.75 mm <sup>2</sup>	0.47 Ω	1.90 Ω	2.30 kg
MCTS/TPS/25/0.75	20 m	0.75 mm <sup>2</sup>	0.59 Ω	2.37 Ω	2.80 kg
MCTS/TPS/30/0.75	30 m	0.75 mm <sup>2</sup>	0.71 Ω	2.85 Ω	3.30 kg

## Total Measuring Resistance at Full Scale. Other Resistance Values in Graphs on page 3.

Transducer	Measuring Resistance
CT 100	25 Ω
CT 200	20 Ω
CT 400	10 Ω
CT 500	5 Ω
CT 1000	4 Ω
CT 2000	3.5 Ω

## Maximum Burden Resistor depending on Transducer and Connection Cable

The remaining burden resistance can be calculated by the subtraction of the connection cable loop resistance from the transducer total measuring resistance.

Example CT 1000 with 15 meters cable 0.34 mm<sup>2</sup> and 0.75 mm<sup>2</sup>:

CT 1000 total measuring resistance: 4 Ω at 1000 A<sub>rms</sub>

MCTS/TPS/15 loop resistance: 3.14 Ω → Maximum allowed burden resistor = 4 Ω - 3.14 Ω = 0.86 Ω

MCTS/TPS/15/0.75 loop resistance: 1.42 Ω → Maximum allowed burden resistor = 4 Ω - 1.42 Ω = 2.58 Ω



# Dimensions

**Rack**

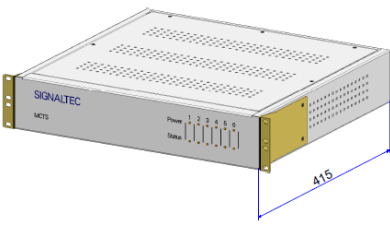
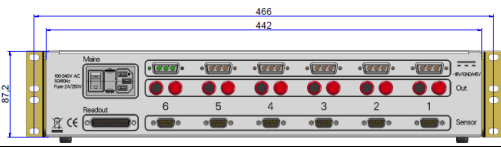
Cabinet Width: 442 mm (19" rack type)  
 Cabinet Height: 87,2 mm (2 HU)  
 Cabinet Depth: 415 mm  
 Mass Basic Unit: 6.8 kg  
 Mass Internal power supply: 0.5 kg  
 Mass 19" mounting brackets: 0.5 kg

**Transducers CT 100, CT 200, CT 400**

Positive current direction

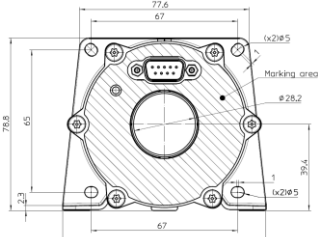
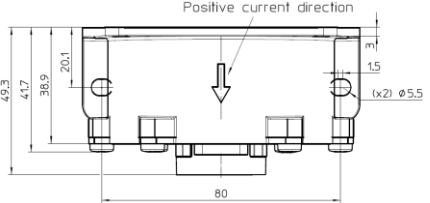
**Transducers CT 500, CT 1000**



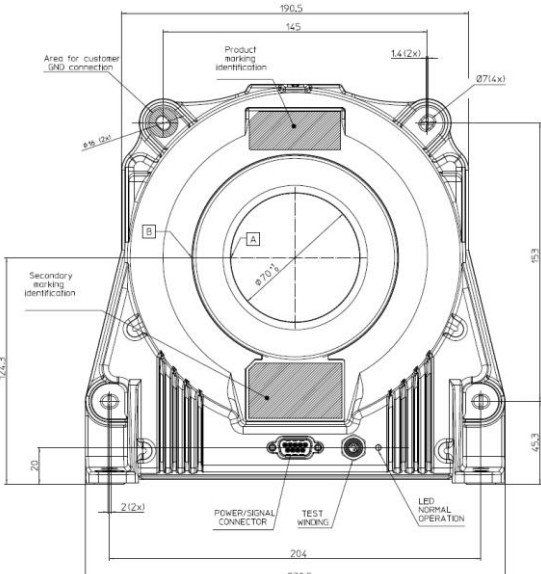
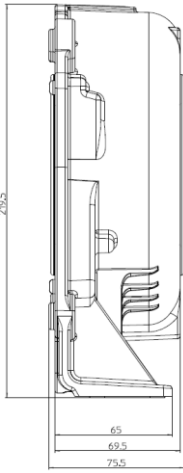
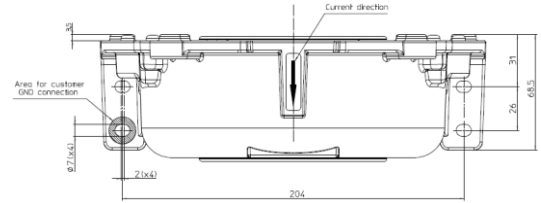

Positive current direction

**Transducer CT 2000**

Current direction

**Passive plug-on burden resistors**











Width: 51 mm  
 Height: 51 mm  
 Depth: 62 mm (Connectors included)  
 Mass: 85 g

**Active plug-on voltage output modules**



Width: 51 mm  
 Height: 51 mm  
 Depth: 62 mm (Connectors included)  
 Mass: 105 g

## Accessories

	<p><b>MCTS/CB</b></p> <p>Carrying bag for rack, transducers, cables and burden modules</p>
	<p><b>TSC</b></p> <p>Transducer soft case for use with carrying bag</p> <p><b>TSC1</b> for CT 100, CT 200, CT 400  <b>TSC2</b> for CT 500, CT 1000  <b>TSC4</b> for CT 2000</p>
	<p><b>MCTS/ROC</b></p> <p>18-pole D-SUB-cable for status-readout-interface, length 3 m</p>
	<p><b>BNC4A</b></p> <p>BNC to 4 mm banana-plug adapter</p>
	<p><b>BPL0.5</b></p> <p>4 mm banana-plug test lead set, length 0.5 m</p>
	<p><b>BPL01</b></p> <p>4 mm banana-plug test lead set, length 1 m</p>
	<p><b>BNCL1</b></p> <p>BNC to BNC test lead, length 1 m</p>
	<p><b>BNC4L1</b></p> <p>BNC to 4 mm banana-plug test lead, length 1 m</p>

## Order Numbers

<b>MCTS Racks</b>	
MCTS2/1CH	Basic unit with one internal power supply including 19" mounting brackets, power cord and manual
MCTS2/2CH	Basic unit with two internal power supplies including 19" mounting brackets, power cord and manual
MCTS2/3CH	Basic unit with three internal power supplies including 19" mounting brackets, power cord and manual
MCTS2/4CH	Basic unit with four internal power supplies including 19" mounting brackets, power cord and manual
MCTS2/5CH	Basic unit with five internal power supplies including 19" mounting brackets, power cord and manual
MCTS2/6CH	Basic unit with six internal power supplies including 19" mounting brackets, power cord and manual
MCTS2/BU	Basic unit without internal power supply including 19" mounting brackets, power cord and manual
MCTS/PS	Internal power Supply
<b>Current Transducers</b>	
CT 100	AC/DC current transducer 100 A <sub>rms</sub>
CT 200	AC/DC current transducer 200 A <sub>rms</sub>
CT 400	AC/DC current transducer 400 A <sub>rms</sub>
CT 500	AC/DC current transducer 500 A <sub>rms</sub>
CT 1000	AC/DC current transducer 1000 A <sub>rms</sub>
CT 2000	AC/DC current transducer 2000 A <sub>rms</sub>
<b>Connection Cables</b>	
MCTS/TPS/1	1.5 meters connection cable, 0.34 mm <sup>2</sup>
MCTS/TPS/1.5	1.5 meters connection cable, 0.34 mm <sup>2</sup>
MCTS/TPS/2.5	2.5 meters connection cable, 0.34 mm <sup>2</sup>
MCTS/TPS/3	3 meters connection cable, 0.34 mm <sup>2</sup>
MCTS/TPS/5	5 meters connection cable, 0.34 mm <sup>2</sup>
MCTS/TPS/10	10 meters connection cable, 0.34 mm <sup>2</sup>
MCTS/TPS/15	15 meters connection cable, 0.34 mm <sup>2</sup>
MCTS/TPS/20	20 meters connection cable, 0.34 mm <sup>2</sup>
MCTS/TPS/2.5/0.75	2.5 meters connection cable, 0.75 mm <sup>2</sup>
MCTS/TPS/5/0.75	5 meters connection cable, 0.75 mm <sup>2</sup>
MCTS/TPS/10/0.75	10 meters connection cable, 0.75 mm <sup>2</sup>
MCTS/TPS/15/0.75	15 meters connection cable, 0.75 mm <sup>2</sup>
MCTS/TPS/20/0.75	20 meters connection cable, 0.75 mm <sup>2</sup>
MCTS/TPS/25/0.75	25 meters connection cable, 0.75 mm <sup>2</sup>
MCTS/TPS/30/0.75	30 meters connection cable, 0.75 mm <sup>2</sup>
<b>Passive Burden Resistors</b>	
MCTS/BR1/0.02	1 Ω plug-on burden resistor for MCTS/TPS
MCTS/BR1.5/0.02	1.5 Ω plug-on burden resistor for MCTS/TPS
MCTS/BR2.5/0.02	2.5 Ω plug-on burden resistor for MCTS/TPS
MCTS/BR3.75/0.02	3.75 Ω plug-on burden resistor for MCTS/TPS
MCTS/BR5/0.02	5 Ω plug-on burden resistor for MCTS/TPS
MCTS/BR10/0.01	10 Ω plug-on burden resistor for MCTS/TPS
MCTS/BR25/0.02	25 Ω plug-on burden resistor for MCTS/TPS
MCTS/BR50/0.02	50 Ω plug-on burden resistor for MCTS/TPS
<b>Active Voltage Output Modules</b>	
MCTS/VM1/0.02	Plug-on output current amplifier 1A/7V
MCTS/VM0.66/0.02	Plug-on output current amplifier 667mA/7V
MCTS/VM0.4/0.02	Plug-on output current amplifier 400mA/7V
MCTS/VM0.26/0.02	Plug-on output current amplifier 267mA/7V
MCTS/VM0.2/0.02	Plug-on output current amplifier 200mA/7V
MCTS/VM0.1/0.02	Plug-on output current amplifier 100mA/7V
<b>Accessories</b>	
MCTS/CB	Carrying bag for MCTS rack, transducers and cables
TSC1	Transducer soft case for CT 100, CT 200, CT 400
TSC2	Transducer soft case for CT 500, CT 1000
TSC4	Transducer soft case for CT 2000
MCTS/ROC	Status readout interface cable, length 3 m
BPL0.5	4mm banana-plug test lead set for MCTS current output terminals, red and black, length 0.5 m
BPL1	4mm banana-plug test lead set for MCTS current output terminals, red and black, length 1 m
BNCL1	BNC to BNC test lead, length 1 m
BNC4L1	BNC to 4 mm banana-plug test lead, length 1 m
BNC4A	BNC to 4 mm banana-plug adapter